

机型	版本
SHD-40U	Ver.E
SHD-40U-HD	Ver.F

					制图	版号	K	标题	SHD-40U	图号	SHD-40U-CE-400V-K-1	比例	第 1 张	
					设计	核准		主电路图				标准	CE	共 5 张
					校对			信易电热机械股份有限公司 Shini Plastics Technologies, Inc.				机器电压	3φ400V	
标记	更改前	更改后	更改人	日期	审核	日期	2024.05.10		机器频率	50Hz				

1 2 3 4 5 6 7 8

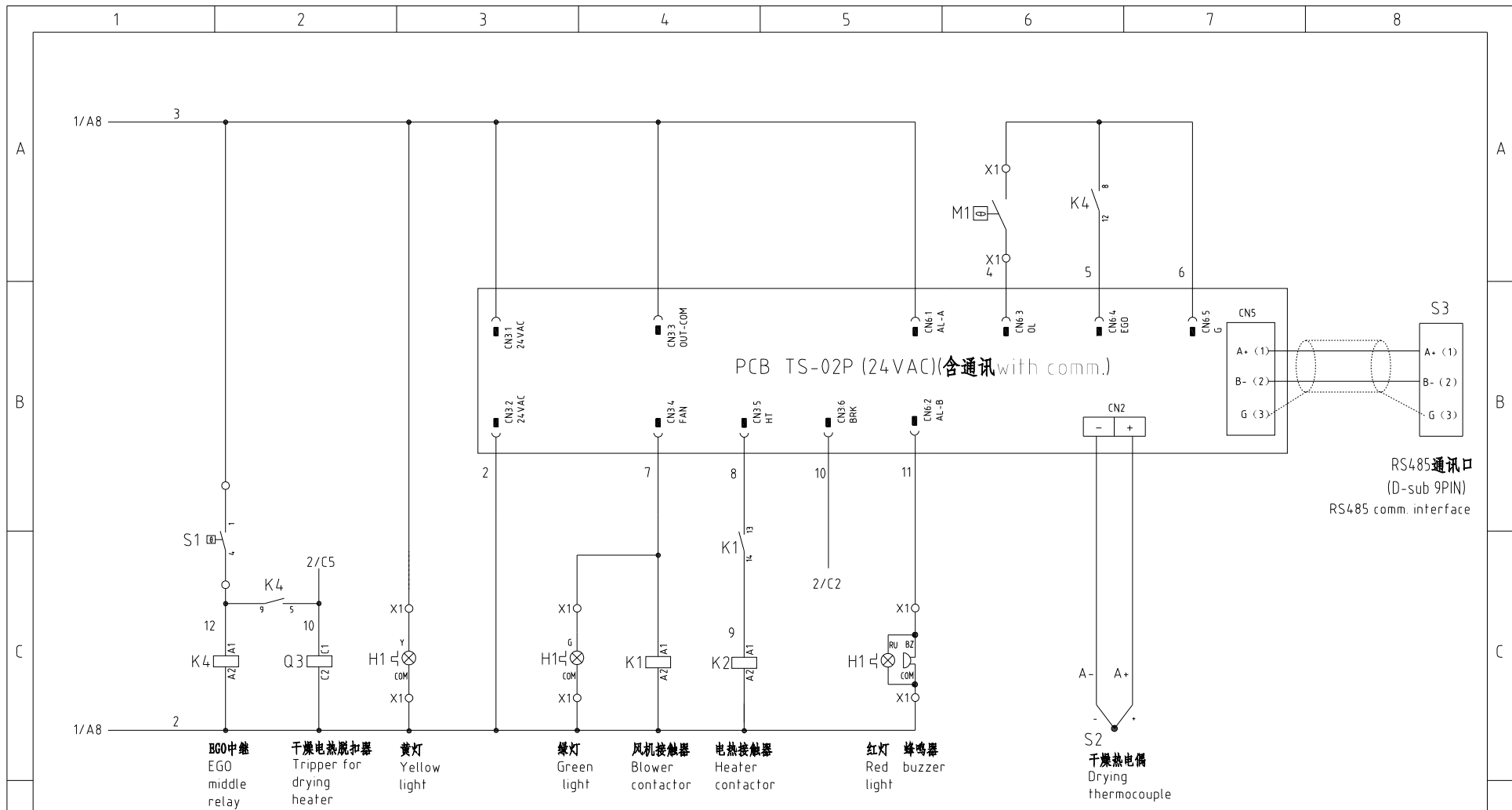

机型	版本
SHD-40U	Ver.E
SHD-40U-HD	Ver.F

Notes: M1 is the overheat protector of drying blower.
 注: M1为干燥风机自带过热保护器

标记		更改前	更改后	更改人	日期	制图	版号	K	标题	图号	比例	第 2 张
									SHD-40U 控制电路图	SHD-40U-CE-400V-K-2	CE	共 5 张
									SHINI 信易电热机械股份有限公司 Shini Plastics Technologies, Inc.		3φ400V	
											50Hz	

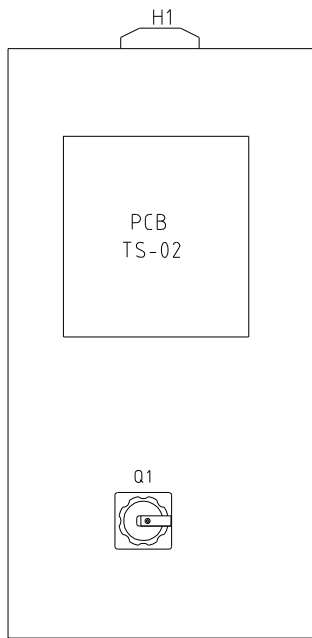

干燥机面板
Panel

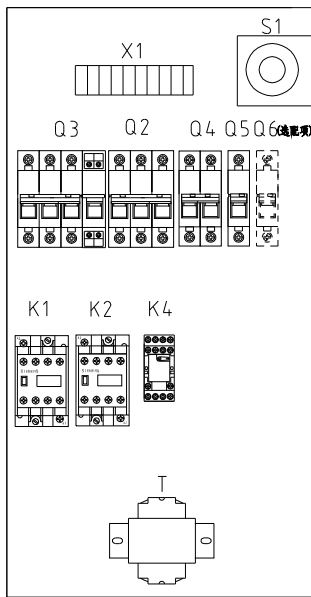

干燥机控制箱
Control box

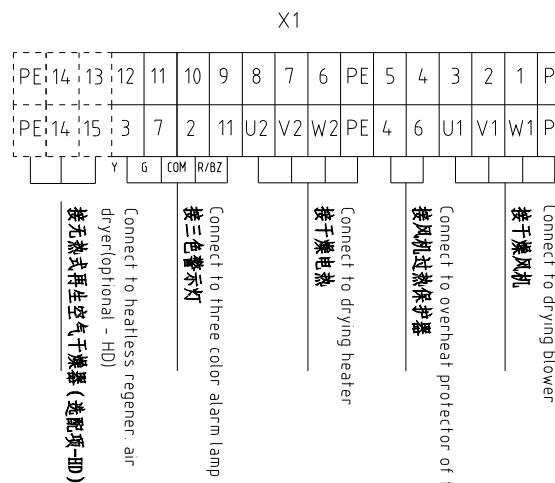

机型	版本
SHD-40U	Ver.E
SHD-40U-HD	Ver.F

Technical Requirement: The main power lines directly connect to main power switch without passing the terminal board.

技术要求: 主电源线不经端子排, 直接接入主电源开关

					制图		版号	K	标题	SHD-40U	图号	SHD-40U-CE-400V-K-3	比例	第 3 张
					设计		核		电气元件布置及端子接线图				标准	CE 共 5 张
					校对		准		信易电热机械股份有限公司 Shini Plastics Technologies, Inc.			机器电压	3φ400V	
标记	更改前	更改后	更改人	日期	审核	日期	2024.05.10			机器频率	50Hz			

信易辅机RS-485通讯接线示意图

Shini auxiliary machine RS-485 comm. wiring diagram

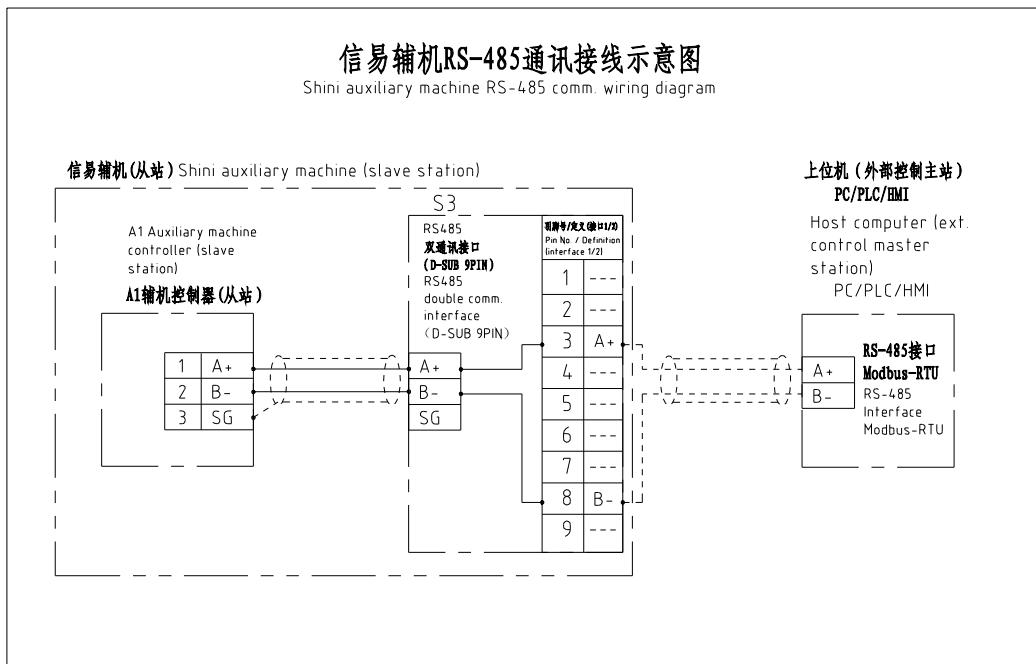

信易RS-485接口定义

Shini RS-485 interface definition

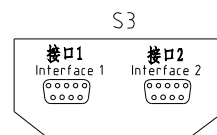

D-sub-9针接口 D-sub-9 pin interface	引脚号 Pin No.	引脚定义 Pin definition
	1	---
	2	---
	3	A+ (RS-485 信号) A+ (RS-485 signal)
	4	---
	5	---
	6	---
	7	---
	8	B- (RS-485 信号) B- (RS-485 signal)
	9	---

- 注: 1. 通讯接口: RS-485 (两线式)
2. 通讯协议: Modbus-RTU
3. 机器配备D-sub9母接头, 客户需自备D-sub9公接头;
4. 接口1和接口2内部并联, 功能相同, 不分主次

Note: 1. Comm. interface: RS-485 (Two wire)
2. Comm. protocol: Modbus-RTU
3. The machine is equipped with D-sub9 female connector, and the customer needs to provide D-sub9 male connector.
4. Interface 1 and interface 2 are connected in parallel and have the same function, which is regardless of primary and secondary.

机型	版本
SHD-40U	Ver.E
SHD-40U-HD	Ver.F

													制图	版号	K	标题	SHD-40U	图号	SHD-40U-CE-400V-K-4	比例	第 4 张
													设计	核准		通讯接线图		标准	CE	共 5 张	
													校对	审核	日期	2024.05.10	信易电热机械股份有限公司 Shini Plastics Technologies, Inc.	机器电压	3φ400V		
标记	更改前	更改后	更改人	日期	机器频率	50Hz															

1 2 3 4 5 6 7 8

1		2		3		4		5		6		7		8	
序号/NO	符号/Symbol	名称/Name		制造商/Manufacturer		型号/Type		规格/Specification		单位/unit	数量/Number	物料编号/Material number		备注/Remark	
A	1	Q1	主电源开关/Main power Switch		EATON		TO-2-1/EA/SVB/20A		20A 3P 690V 50/60Hz		PCS	1	YE10021160000		
	2	Q2	断路器/Circuit-breaker		TECO		BM-63C/3006S		6A 3P		PCS	1	YE40300603000		
	3	Q3	断路器/Circuit-breaker		TECO		BM-63C/3010S		10A 3P		PCS	1	YE40301003000		
	4		励磁脱扣器/Excitation release		YIJIN		MX		24V 50/60Hz		PCS	1	YE40024000000		
	5	Q4	断路器/Circuit-breaker		TECO		BM-63C/2003S		3A 2P		PCS	1	YE40200203000		
	6	Q5	断路器/Circuit-breaker		TECO		BM-63C/1003S		3A 1P		PCS	1	YE40100203000		
	7	Q6	断路器/Circuit-breaker		TECO		BM-63C/1003S		3A 1P		PCS	1	YE40100203000		(2)
B	8	K1	交流接触器/AC Contactor		SIEMENS		3RT6015-1AB01		7A 3P 1NO 24V AC		PCS	1	YE00601502500		
	9		辅助触点/Auxiliary contactor		SIEMENS		3RH6911-1AA10		1NO		PCS	1	YE00691110000		(2)
	10	K2	交流接触器/AC Contactor		SIEMENS		3RT6016-1AB01		9A 3P 24V AC		PCS	1	YE00601602500		
	11	K4	中间继电器/Middle relay		HONEYWELL		GR-2C-AC24V底座 base PGR-2C-E		24V 50/60Hz		PCS	1	YE03022400300		
	12	T	互感变压器/Sensor transformer		JIUXIN		IN=400V/415V OUT=24V		80VA		PCS	1	YE70040006500		
	13	T	互感变压器/Sensor transformer		JIUXIN		IN=400V/415V OUT=24V/230V		120VA 350MA		PCS	1	YE70040003600		(2)
	14	PCB	干燥机控制器/Dryer controller		PUMP		TS-02C(24VAC/DC)组合件 Assembly		24V 50/60Hz		PCS	1	YE80022406500		
C	15	S1	温度保护器/Overheat protector		EGO		----		115-320 °C		PCS	1	BH90115000150		
	16	S3	通信接口板RS-485(双芯-4芯线) Communication interface board RS-485 (double-lead-4pin connector)		YUYUN		----		----		PCS	1	YE90048501200		
	17		外壳RS485(SAL-700G-A-19)0版 Shell RS485(SAL-700G-A-19)0		BINCHENG		----		----		PCS	1	YR40048500000		
	18	H1	三色警报灯/3-color alarm lamp		SHINI		红黄绿三色灯+蜂鸣器 Red, yellow, green lights + buzzer		24V AC/DC		PCS	1	BL90002401520		
	19	X1	端子排/Terminal board		HOEYWELL		SK2 5		2.5mm ²		PCS	12	YE60002503200		
	20		端子排/Terminal board		HOEYWELL		GK2 5PE		2.5mm ² PE		PCS	2	YE60002503400		
	21		终端固定件 Terminal fittings		HOEYWELL		----		----		PCS	6	YE60000003900		
D	Notes: (1)Means it's not the material inside the control box. (2)Option with Heatless regen. air dryer(-HD).														
	机型		版本												
	SHD-40U		Ver.E												
	SHD-40U-HD		Ver.F		注: (1)表示非电控箱内材料 (2)表示选配项无热式再生空气干燥器(-HD)										
				制图		版号		K		标题		图号		比例	
				设计		核				SHD-40U		SHD-40U-CE-400V-K-5		第 5 张	
				校对		准				电气元件明细表一		标准		CE 共 5 张	
标记		更改前		更改后		更改人		日期		2024.05.10		SHINI 信易电热机械股份有限公司 Shini Plastics Technologies, Inc.		机器电压 3φ400V	
1		2		3		4		5		6		7		8	

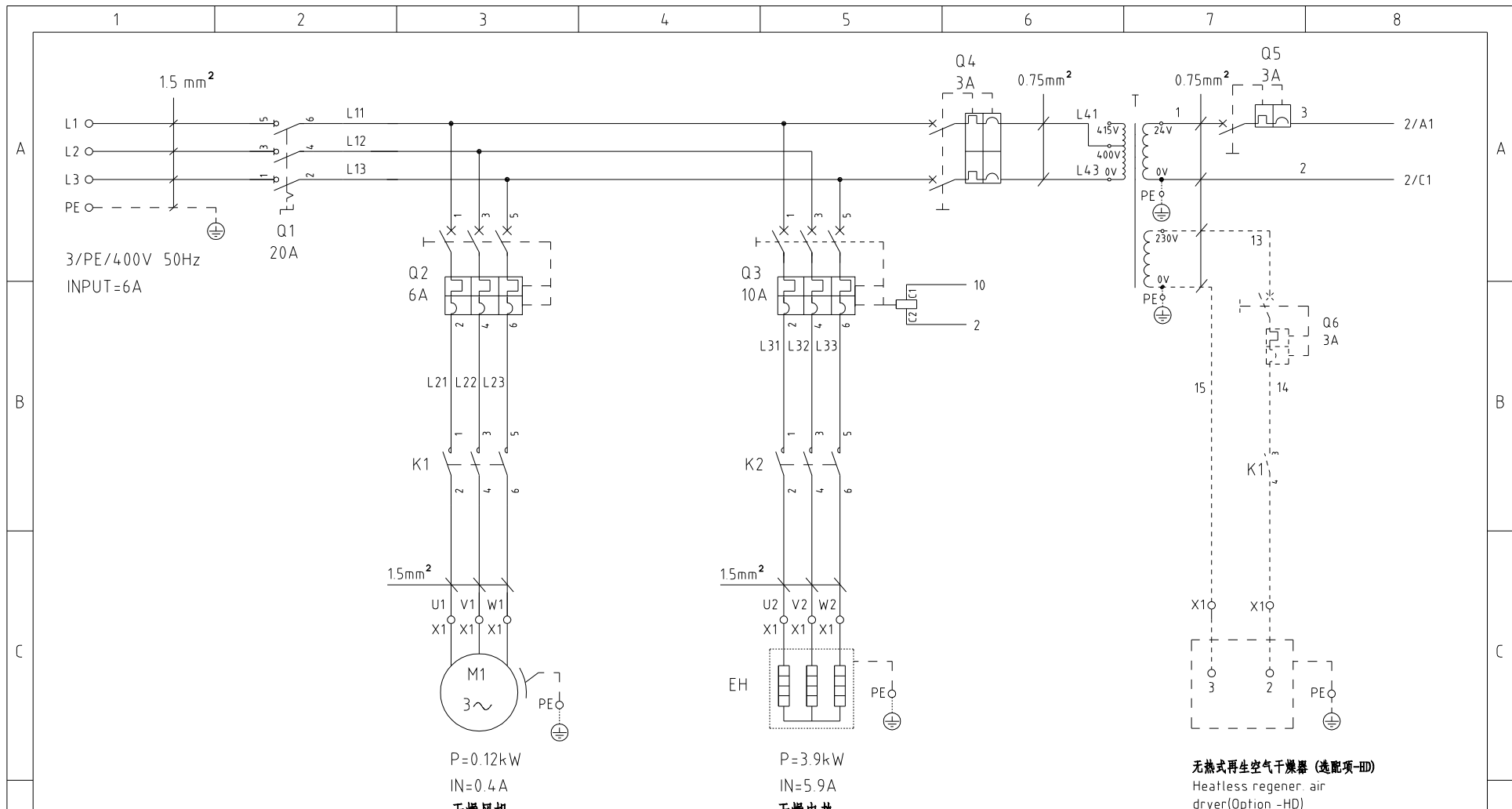

P=0.12kW
IN=0.4A
干燥风机
Drying Blower

P=3.9kW
IN=5.9A
干燥电热
Drying Heater

无热式再生空气干燥器 (选配项-HD)
Heatless regener. air
dryer(Option -HD)

机型	版本
SHD-80U/120U	Ver.E
SHD-80U/120U-HD	Ver.F

					制图		版号	K	标题	SHD-80U/120U	图号	SHD-80U/120U-CE-400V-K-1	比例	第 1 张
					设计		核准		主电路图				标准	CE
					校对		核准		信易電熱機械股份有限公司 Shini Plastics Technologies, Inc.				机器电压	3φ400V
标记	更改前	更改后	更改人	日期	审核	日期	2024.05.10			机器频率	50Hz			

1

2

3

4

5

6

7

8

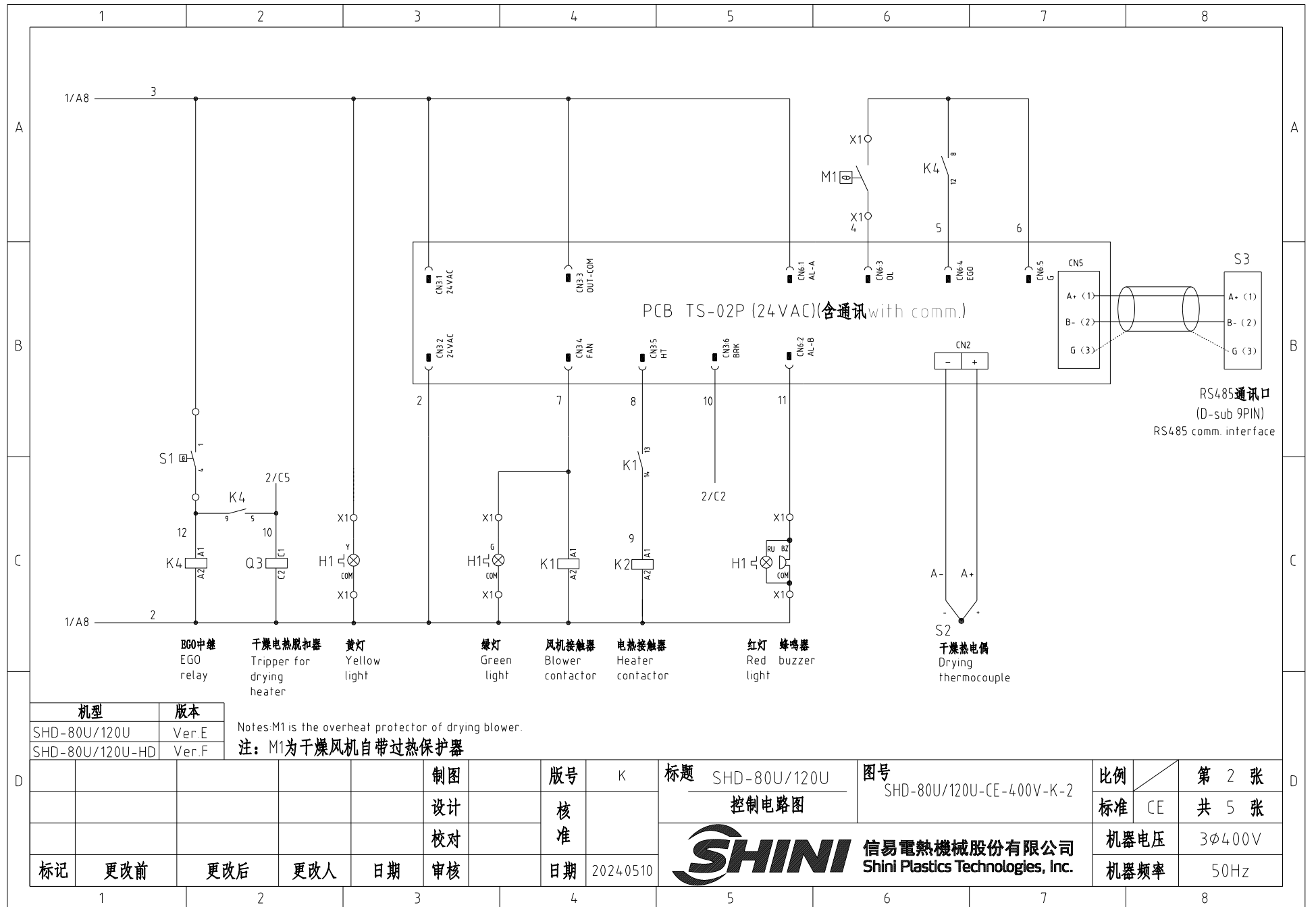

机型	版本
SHD-80U/120U	Ver.E
SHD-80U/120U-HD	Ver.F

Notes: M1 is the overheat protector of drying blower.
 注: M1为干燥风机自带过热保护器

D	制图	版号	K	标题	SHD-80U/120U	图号	SHD-80U/120U-CE-400V-K-2	比例	第 2 张
	设计	核准		控制电路图			标准	CE	共 5 张
	校对	核准		 信易电热机械股份有限公司 Shini Plastics Technologies, Inc.	机器电压	3φ400V			
	标记	更改前	更改后		更改人	日期	2024.05.10	机器频率	50Hz

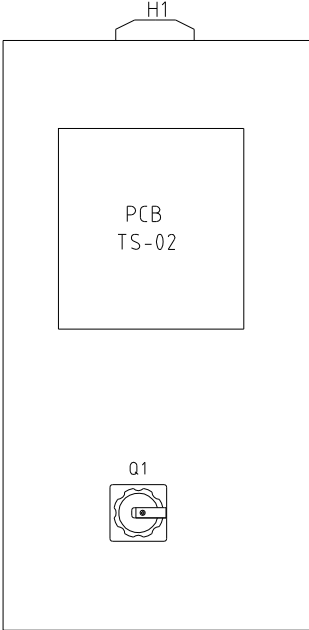
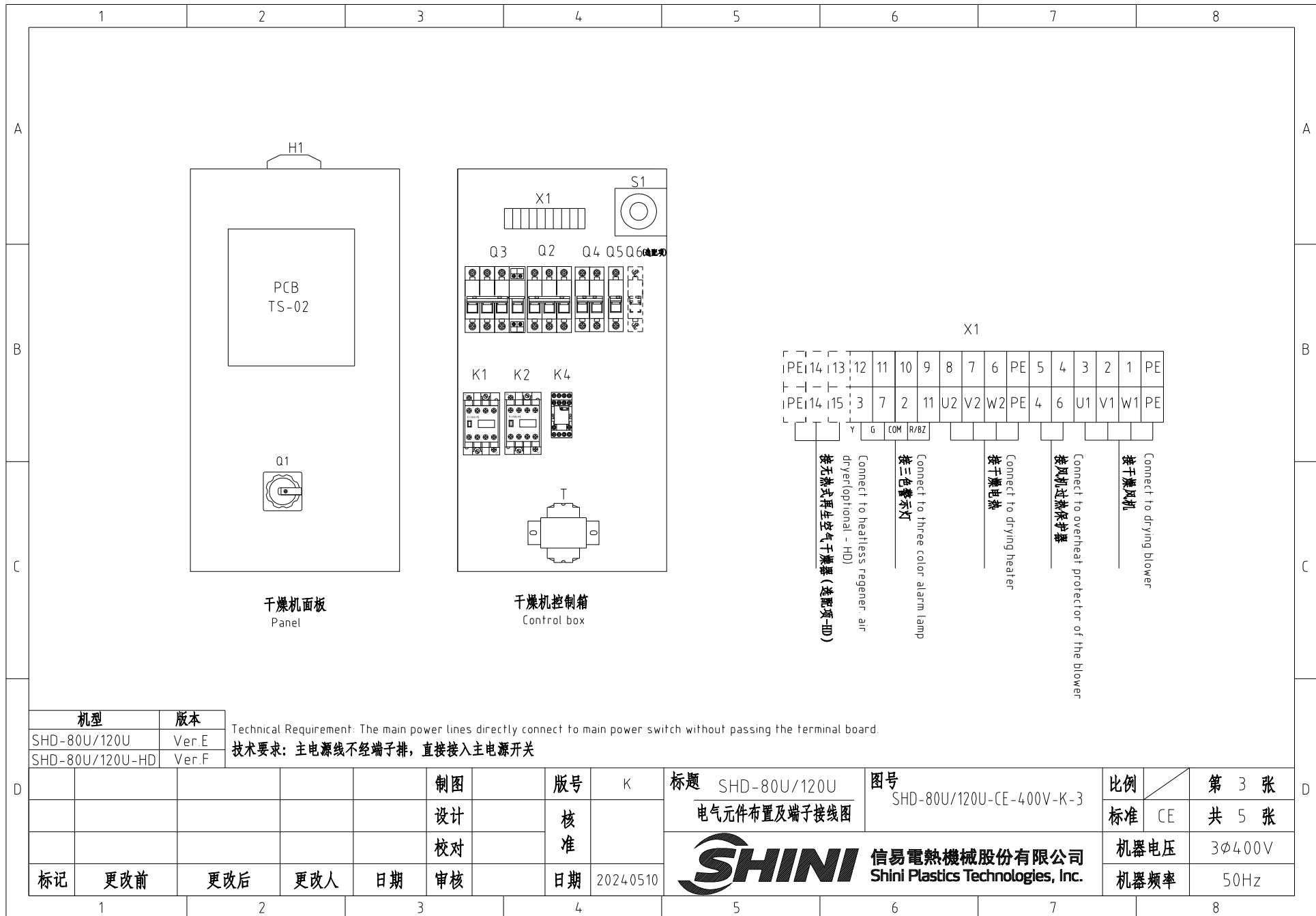

干燥机面板
Panel

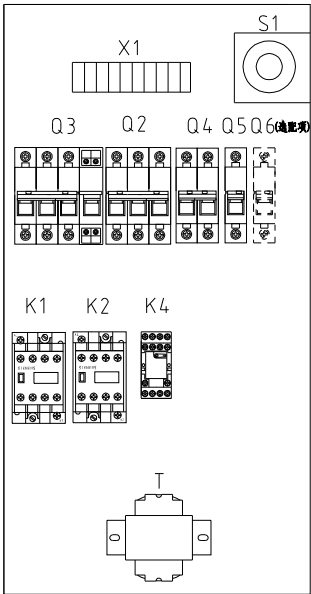

干燥机控制箱
Control box

X1																	
1	2	3	4	5	6	PE	7	8	9	10	11	12	13	14	15	16	
U1	V1	W1	PE	4	6	U2	V2	W2	PE	3	7	2	11	Y	G	COM	R/BZ
Connect to drying blower			Connect to overheat protector of the blower			Connect to drying heater			Connect to three color alarm lamp			Connect to heatless regenerative air dryer (optional - HD)			接无热式再生空气干燥器 (选配项-HD)		

机型	版本
SHD-80U/120U	Ver.E
SHD-80U/120U-HD	Ver.F

Technical Requirement: The main power lines directly connect to main power switch without passing the terminal board.
技术要求: 主电源线不经端子排, 直接接入主电源开关

					制图	版号		K	标题	SHD-80U/120U	图号	SHD-80U/120U-CE-400V-K-3	比例	第 3 张
					设计	核准			电气元件布置及端子接线图			标准	CE	共 5 张
					校对				信易电热机械股份有限公司 Shini Plastics Technologies, Inc.			机器电压	3φ400V	
标记	更改前	更改后	更改人	日期	审核	日期	2024.05.10				机器频率	50Hz		

信易辅机RS-485通讯接线示意图

Shini auxiliary machine RS-485 comm. wiring diagram

信易辅机(从站) Shini auxiliary machine (slave station)

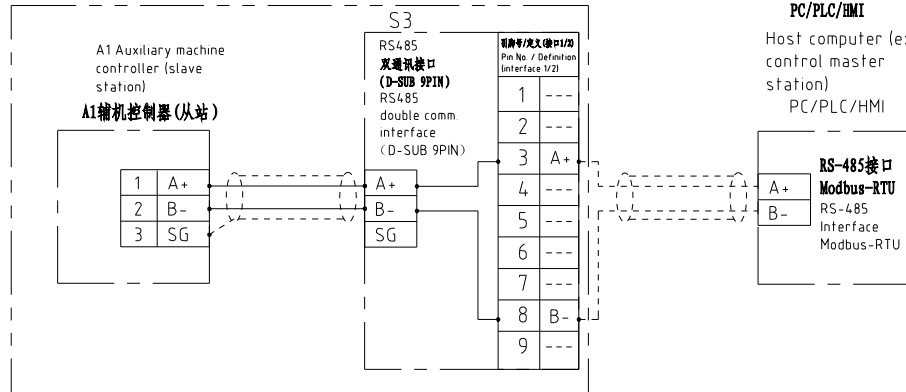

信易RS-485接口定义
Shini RS-485 interface definition

S3

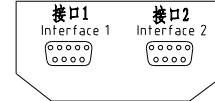

D-sub-9针接口 D-sub-9 pin interface	引脚号 Pin No.	引脚定义 Pin definition
	1	-
	2	-
	3	A+ (RS-485 信号) A+ (RS-485 signal)
	4	-
	5	-
	6	-
	7	-
	8	B- (RS-485 信号) B- (RS-485 signal)
	9	-

注: 1. 通讯接口: RS-485 (两线式)

2. 通讯协议: Modbus-RTU

3. 机器配备D-sub9母接头, 客户需自备D-sub9公接头;

4. 接口1和接口2内部并联, 功能相同, 不分主次

Note: 1. Comm. interface: RS-485 (two wire)

2. Comm. protocol: Modbus-RTU

3. The machine is equipped with D-sub9 female connector, and the customer needs to provide D-sub9 male connector;

4. Interface 1 and interface 2 are connected in parallel and have the same function, which is regardless of primary and secondary.

机型	版本
SHD-80U/120U	Ver.E
SHD-80U/120U-HD	Ver.F

制图	版号	K	标题	SHD-80U/120U	图号	SHD-80U/120U-CE-400V-K-4	比例	第 4 张	
设计	核准		通讯接线图				标准	CE	
校对	核准						机器电压	3φ400V	
标记	更改前	更改后	更改人	日期	审核	日期	2024.05.10	机器频率	50Hz



信易电热机械股份有限公司
Shini Plastics Technologies, Inc.

1		2		3		4		5		6		7		8	
序号/NO	符号/Symbol	名称/Name	制造商/Manufacturer	型号/Type	规格/Specification	单位/unit	数量/Number	物料编号/Material number	备注/Remark						
1	Q1	主电源开关/Main power Switch	EATON	TO-2-1/EA/SVB/20A	20A 3P 690V 50/60Hz	PCS	1	YE10021160000							
2	Q2	断路器/Circuit-breaker	TECO	BM-63C/3006S	6A 3P	PCS	1	YE40300603000							
3	Q3	断路器/Circuit-breaker	TECO	BM-63C/3010S	10A 3P	PCS	1	YE40301003000							
4		励磁脱扣器/Excitation release	YIJIN	MX	24V 50/60Hz	PCS	1	YE40024000000							
5	Q4	断路器/Circuit-breaker	TECO	BM-63C/2003S	3A 2P	PCS	1	YE40200203000							
6	Q5	断路器/Circuit-breaker	TECO	BM-63C/1003S	3A 1P	PCS	1	YE40100203000							
7	Q6	断路器/Circuit-breaker	TECO	BM-63C/1003S	3A 1P	PCS	1	YE40100203000	(2)						
8	K1	交流接触器/AC Contactor	SIEMENS	3RT6015-1AB01	7A 3P 1NO 24V AC	PCS	1	YE00601502500							
9		辅助触点/Auxiliary contactor	SIEMENS	3RH6911-1AA10	1NO	PCS	1	YE00691110000	(2)						
10	K2	交流接触器/AC Contactor	SIEMENS	3RT6017-1AB01	12A 3P 24V AC	PCS	1	YE00601702500							
11	K4	中间继电器/Middle Relay	HONEYWELL	GR-2C-AC24V底座 base PGR-2C-E	24V 50/60Hz	PCS	1	YE03022400300							
12	T	互感变压器/Sensor Transformer	JIUXIN	IN=400V/415V OUT=24V	80VA	PCS	1	YE70040006500							
13	T	互感变压器/Sensor Transformer	JIUXIN	IN=400V/415V OUT=24V/230V	120VA 350MA	PCS	1	YE70040003600	(2)						
14	PCB	干燥机控制器/Dryer controller	PUMP	TS-02C(24VAC/DC)附件 Assembly	24V 50/60Hz	PCS	1	YE80022406500							
15	S1	温度保护器/Overheat protector	EGO	----	115-320 °C	PCS	1	BH90115000150							
16	S3	通信接口板 RS-485 (双芯双绞线) Communication interface board RS-485 (double shielded twisted pair)	YUYUN	----	----	PCS	1	YE90048501200							
17		外壳RS485 (SAL-700G-A-19) 0版 Shell RS485 (SAL-700G-A-19) 0	BINCHENG	----	----	PCS	1	YR40048500000							
18	H1	三色警报灯/3-color alarm lamp	SHINI	红黄绿三色灯+蜂鸣器 Red, yellow, green lights + buzzer	24V AC/DC	PCS	1	BL90002401520							
19	X1	端子排/Terminal board	HOEYWELL	SK2.5	2.5mm ²	PCS	12	YE60002503200							
20		端子排/Terminal board	HOEYWELL	GK2.5PE	2.5mm ² PE	PCS	2	YE60002503400							
21		终端固定件 Terminal fittings	HOEYWELL	----	PCS	PCS	6	YE60000003900							
<p>Notes:</p> <p>(1)Means it's not the material inside the control box.</p> <p>(2)Option with Heatless regen. air dryer(-HD).</p> <p>注: (1)表示非电控箱内材料 (2)表示选配项无热式再生空气干燥器(-HD)</p>															
机型		版本													
SHD-80U/120U		Ver.E													
SHD-80U/120U-HD		Ver.F													
				制图	版号		K	标题		图号		比例	第 5 张		
				设计	核			SHD-80U/120U		SHD-80U/120U-CE-400V-K-5		标准	共 5 张		
				校对	准			电气元件明细表一				机器电压	3φ400V		
标记	更改前	更改后	更改人	日期	审核	日期	2024.05.10			信易電熱機械股份有限公司 Shini Plastics Technologies, Inc.		机器频率	50Hz		
1		2		3		4		5		6		7		8	

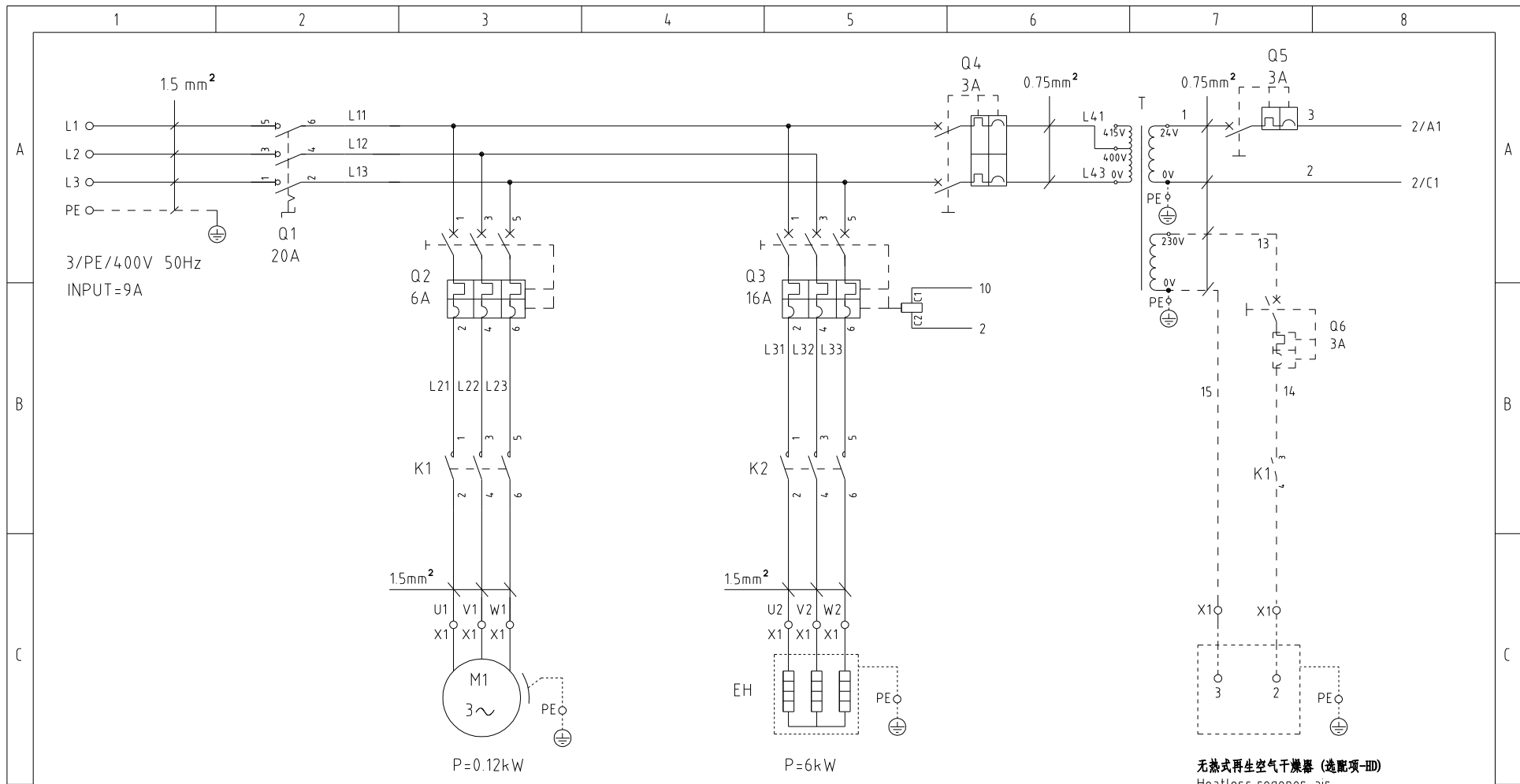

P=0.12kW
IN=0.4A
干燥风机
Drying Blower

P=6kW
IN=9A
干燥电热
Drying Heater

无热式再生空气干燥器 (选配项-HD)
Heatless regenerative air dryer (Option -HD)

机型	版本
SHD-230U	Ver.D
SHD-230U-HD	Ver.E

					制图		版号	K	标题	SHD-230U 主电路图	图号	SHD-230U-CE-400V-K-1	比例	第 1 张
					设计		核准						标准	CE
					校对								机器电压	3φ400V
标记	更改前	更改后	更改人	日期	审核		日期	2024.05.10	信易电热机械股份有限公司 Shini Plastics Technologies, Inc.				机器频率	50Hz

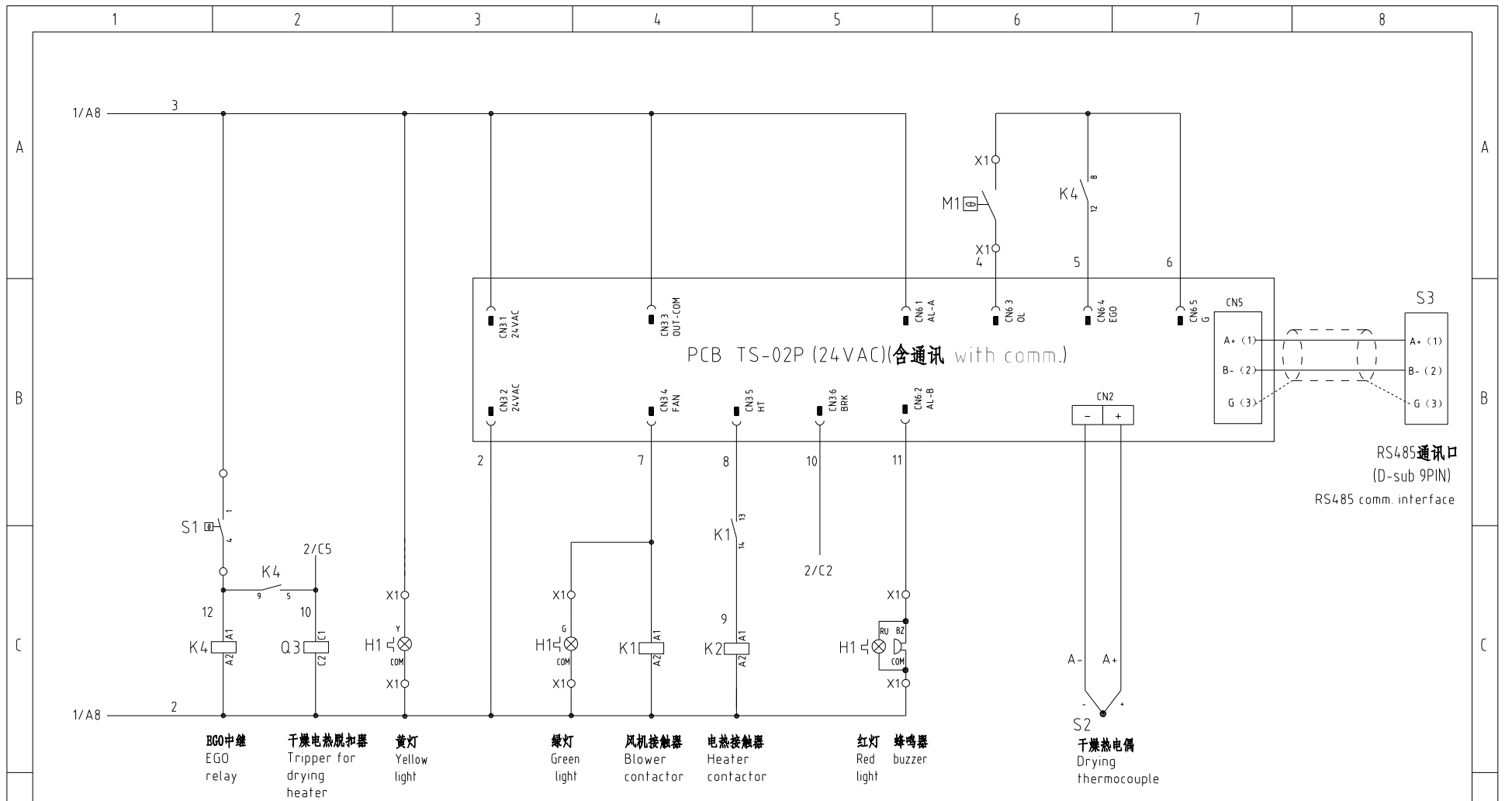

- BGO中继电器 EGO relay
- 干燥电热脱扣器 Tripper for drying heater
- 黄灯 Yellow light
- 绿灯 Green light
- 风机接触器 Blower contactor
- 电热接触器 Heater contactor
- 红灯 Red light
- 蜂鸣器 Buzzer
- 干燥热电偶 Drying thermocouple

RS485 通讯口
(D-sub 9PIN)
RS485 comm. interface

机型	版本
SHD-230U	Ver.D
SHD-230U-HD	Ver.E

Notes: M1 is the overheater of drying blower.

注: M1为干燥风机自带过热保护器

D	制图					版号		K	标题		SHD-230U 控制电路图	图号		SHD-230U-CE-400V-K-2	比例	第 2 张 共 5 张
	设计					核准			SHINI			信易电热机械股份有限公司 Shini Plastics Technologies, Inc.	标准		CE	
	校核					日期		2024.05.10			机器电压	3φ400V				
标记					更改前	更改后	更改人		日期	审核			机器频率	50Hz		

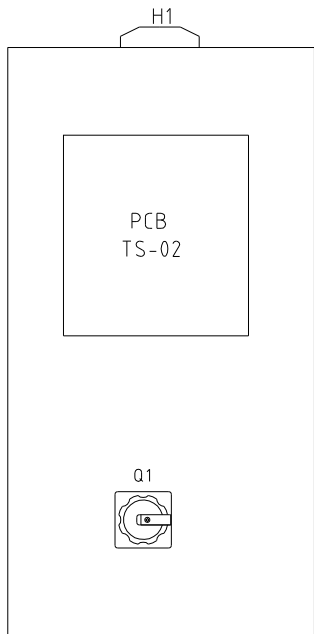

干燥机面板
Panel

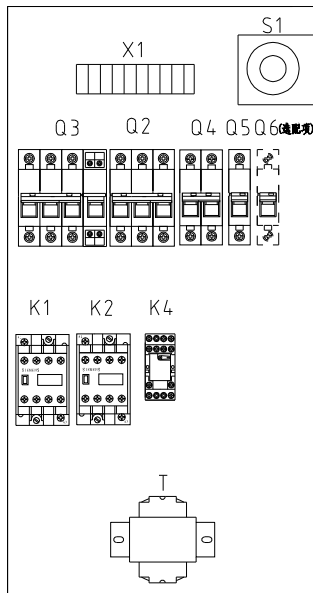

干燥机控制箱
Control box

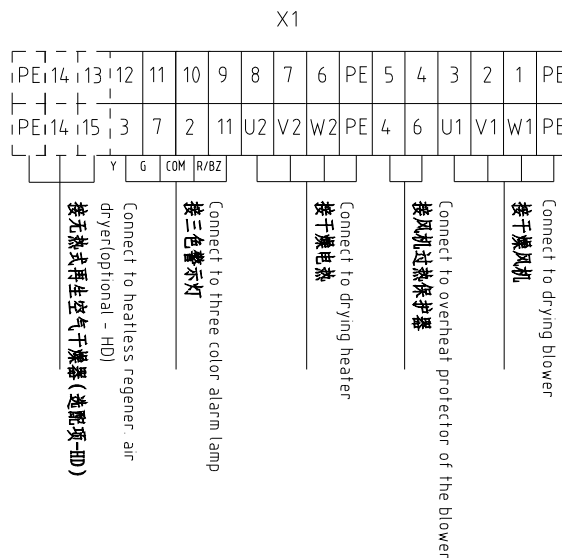

机型	版本
SHD-230U	Ver.D
SHD-230U-HD	Ver.E

Technical Requirement: The main power lines directly connect to main power switch without passing the terminal board.

技术要求: 主电源线不经端子排, 直接接入主电源开关

					制图		版号	K	标题	SHD-230U	图号	SHD-230U-400V-CE-K-3	比例	第 3 张
					设计		核准		电气元件布置及端子接线图				标准	CE
					校对		核准		信易电热机械股份有限公司 Shini Plastics Technologies, Inc.				机器电压	3φ400V
标记	更改前	更改后	更改人	日期	审核	日期	2024.05.10							机器频率

信易辅机RS-485通讯接线示意图

Shini auxiliary machine RS-485 comm. wiring diagram

信易辅机(从站) Shini auxiliary machine (slave station)

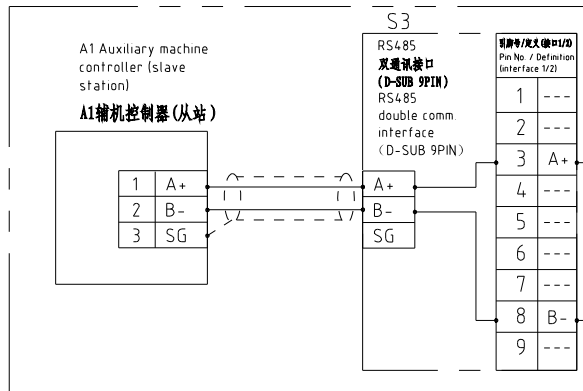

上位机 (外部控制主站)
PC/PLC/HMI

Host computer (ext. control master station)
PC/PLC/HMI

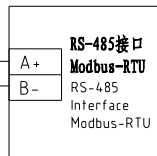

信易RS-485接口定义

Shini RS-485 interface definition

S3

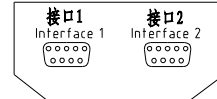

D-sub-9针接口 D-sub-9 pin interface	引脚号 Pin No.	引脚定义 Pin definition
	1	-
	2	-
	3	A+ (RS-485 信号) A+ (RS-485 signal)
	4	-
	5	-
	6	-
	7	-
	8	B- (RS-485 信号) B- (RS-485 signal)
	9	-

- 注: 1. 通讯接口: RS-485 (两线式)
2. 通讯协议: Modbus-RTU
3. 机器配备D-sub9母接头, 客户需自备D-sub9公接头;
4. 接口1和接口2内部并联, 功能相同, 不分主次

Note: 1 Comm. interface: RS-485 (two wire)
2 Comm. protocol: Modbus-RTU
3 The machine is equipped with D-sub9 female connector, and the customer needs to provide D-sub9 male connector;
4. Interface 1 and interface 2 are connected in parallel and have the same function, which is regardless of primary and secondary.

机型	版本
SHD-230U	Ver.D
SHD-230U-HD	Ver.E

					制图		版本号	K	标题	SHD-230U 通讯接线图	图号	SHD-230U-400V-CE-K-4	比例	第 4 张
					设计		核准						标准	CE
					校对		核准						机器电压	3φ400V
标记	更改前	更改后	更改人	日期	审核		日期	2024.05.10					机器频率	50Hz



信易电热机械股份有限公司
Shini Plastics Technologies, Inc.

1		2		3		4		5		6		7		8			
序号/NO	符号/Symbol	名称/Name		制造商/Manufacturer		型号/Type		规格/Specification		单位/unit	数量/Number	物料编号/Material number		备注/Remark			
A	1	Q1	主电源开关/Main power Switch		EATON		TO-2-1/EA/SVB/20A		20A 3P 690V 50/60Hz		PCS	1	YE10021160000				
	2	Q2	断路器/Circuit-breaker		TECO		BM-63C/3006S		6A 3P		PCS	1	YE40300603000				
	3	Q3	断路器/Circuit-breaker		TECO		BM-63C/3016S		16A 3P		PCS	1	YE40301603000				
	4		励磁脱扣器/Excitation release		YIJIN		MX		24V 50/60Hz		PCS	1	YE40024000000				
	5	Q4	断路器/Circuit-breaker		TECO		BM-63C/2003S		3A 2P		PCS	1	YE40200203000				
	6	Q5	断路器/Circuit-breaker		TECO		BM-63C/1003S		3A 1P		PCS	1	YE40100203000				
	7	Q6	断路器/Circuit-breaker		TECO		BM-63C/1003S		3A 1P		PCS	1	YE40100203000		(2)		
B	8	K1	交流接触器/AC Contactor		SIEMENS		3RT6015-1AB01		7A 3P 1NO 24V AC		PCS	1	YE00601502500				
	9		辅助触点/Auxiliary contactor		SIEMENS		3RH6911-1AA10		1NO		PCS	1	YE00691110000		(2)		
	10	K2	交流接触器/AC Contactor		SIEMENS		3RT6017-1AB01		12A 3P 24V AC		PCS	1	YE00601702500				
	11	K4	中间继电器/Middle Relay		HONEYWELL		GR-2C-AC24V底座 base PGR-2C-E		24V 50/60Hz		PCS	1	YE03022400300				
	12	T	互感变压器/Sensor Transformer		JIUXIN		IN=400V/415V OUT=24V		80VA		PCS	1	YE70040006500				
	13	T	互感变压器/Sensor Transformer		JIUXIN		IN=400V/415V OUT=24V/230V		120VA 350MA		PCS	1	YE70040003600		(2)		
	14	PCB	干燥机控制器/Dryer controller		PUMP		TS-02C(24VAC/DC)附件 Assembly		24V 50/60Hz		PCS	1	YE80022406500				
C	15	S1	温度保护器/Overheat protector		EGO		----		115-320 °C		PCS	1	BH90115000150				
	16	S3	通信接口板 RS-485 (双端接口板) Communication interface board RS-485 (double Dash-pin connector)		YUYUN		----		----		PCS	1	YE90048501200				
	17		外壳RS485 (SAL-700G-A-19) 0版 Shell RS485 (SAL-700G-A-19) 0		BINCHENG		----		----		PCS	1	YR40048500000				
	18	H1	三色警报灯/3-color alarm lamp		SHINI		红黄绿蜂鸣器 Red, yellow, green lights + buzzer		24V AC/DC		PCS	1	BL90002401520				
	19	X1	端子排/Terminal board		HOEYWELL		SK2.5		2.5mm ²		PCS	12	YE60002503200				
	20		端子排/Terminal board		HOEYWELL		GK2.5PE		2.5mm ² PE		PCS	2	YE60002503400				
	21		终端固定件 Terminal fittings		HOEYWELL		----		PCS		PCS	6	YE60000003900				
D	Notes: (1)Means it's not the material inside the control box. (2)Option with Heatless regen. air dryer(-HD) 注: (1)表示非电控箱内材料 (2)表示选配项无热式再生空气干燥器(-HD)																
	机型		版本		制图		版号		标题		图号		比例		第 5 张		
	SHD-230U		Ver.D				K		SHD-230U		SHD-230U-400V-CE-K-5		CE		共 5 张		
	SHD-230U-HD		Ver.E						电气元件明细表一				机器电压		3φ400V		
标记		更改前		更改后		更改人		日期		2024.05.10		SHINI 信易电热机械股份有限公司 Shini Plastics Technologies, Inc.		机器频率		50Hz	
1		2		3		4		5		6		7		8			

1		2		3		4		5		6		7		8	
序号/NO	符号/Symbol	名称/Name		制造商/Manufacturer		型号/Type		规格/Specification		单位/unit	数量/Number	物料编号/Material number		备注/Remark	
22	S2	热电偶/Thermocouple		----		K Type		----		----	1	----		(1)	
23	M1	风机/Blower		----		----		400V 50HZ		----	1	----		(1)	
24	EH1	电热/Heater		----		----		400V 50HZ		----	1	----		(1)	
机型		版本		Notes: (1)Means it's not the material inside the control box. 注: (1)表示非电控箱内材料											
SHD-230U		Ver.D													
SHD-230U-HD		Ver.E													
				制图		版号		K		标题		图号		比例	
				设计		核				SHD-230U		SHD-230U-CE-400V-K-5/1		第 5/1 张	
				校对		准				电气元件明细表二		标准		CE 共 5 张	
标记		更改前		更改后		更改人		日期		审核		日期		2024.05.10	
												信易電熱機械股份有限公司		Shini Plastics Technologies, Inc.	
												机器电压		3φ400V	
												机器频率		50Hz	