

Note: 1.M1 is the overheating protector of the drying blower;
2. S4 is overheating protector

机型版本 Ver.C

				Drawer	Version	C	Title	SHD-12EB	Drawing NO	Scale	Page	1
				Designer	Approved by		Electrical Principle	SHD-12EB-GB-230V-C-1		Standard	GB	Totally 3 Pages
				Proofread by	Date	20201208	 信易電熱機械股份有限公司 Shini Plastics Technologies, Inc.		Voltage		3φ/230V	
				Checked by					Frequency		50Hz	

Mark	Before modification	After modification	Modified by	Modify date	Checked by	Date	20201208	5	6	7	8
------	---------------------	--------------------	-------------	-------------	------------	------	----------	---	---	---	---

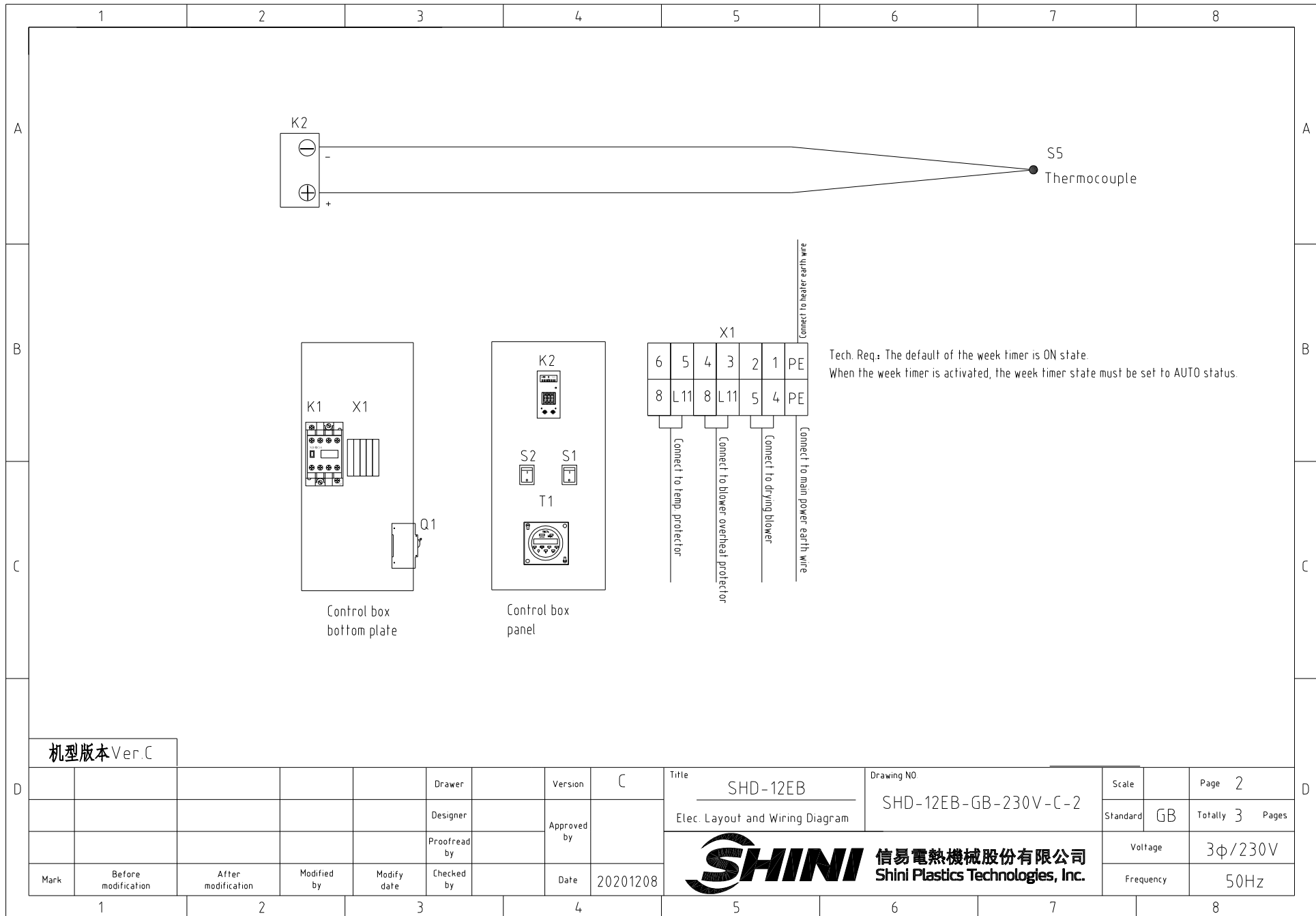

Tech. Req.: The default of the week timer is ON state.
 When the week timer is activated, the week timer state must be set to AUTO status.

机型版本 Ver.C

					Drawer	Version	C	Title	SHD-12EB	Drawing NO	SHD-12EB-GB-230V-C-2	Scale	Page	2	
					Designer	Approved by		Elec. Layout and Wiring Diagram				Standard	GB	Totally	3 Pages
					Proofread by	Date	20201208	 信易電熱機械股份有限公司 Shini Plastics Technologies, Inc.				Voltage	3φ/230V		
Mark	Before modification	After modification	Modified by	Modify date	Checked by							Frequency	50Hz		

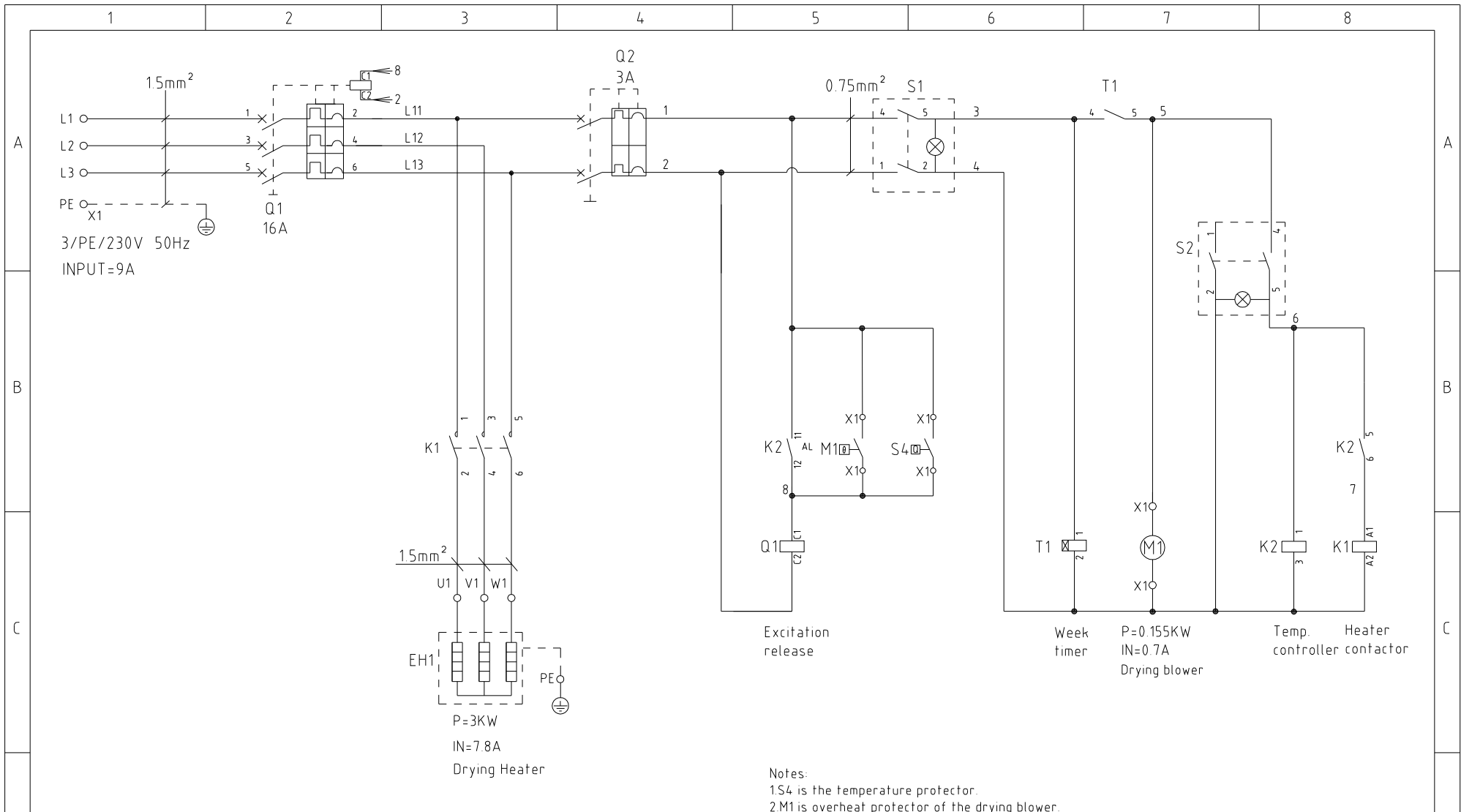

Notes:
 1.S4 is the temperature protector.
 2.M1 is overheat protector of the drying blower.
 3.Pipe heater SHD-25EB-150EB adopts lead in the connection for overheat protection.

机型版本 Ver.E

制图	版号	E	标题	SHD-25EB	图号	SHD-25EB-GB-230V-E-1	比例	第 1 张
设计	核准		Electrical Diagram			标准	GB	共 3 张
校对	日期	20210719	 信易電熱機械股份有限公司 Shini Plastics Technologies, Inc.		机器电压	3φ/230V		
标记	更改前	更改后			更改人	日期	机器频率	50Hz

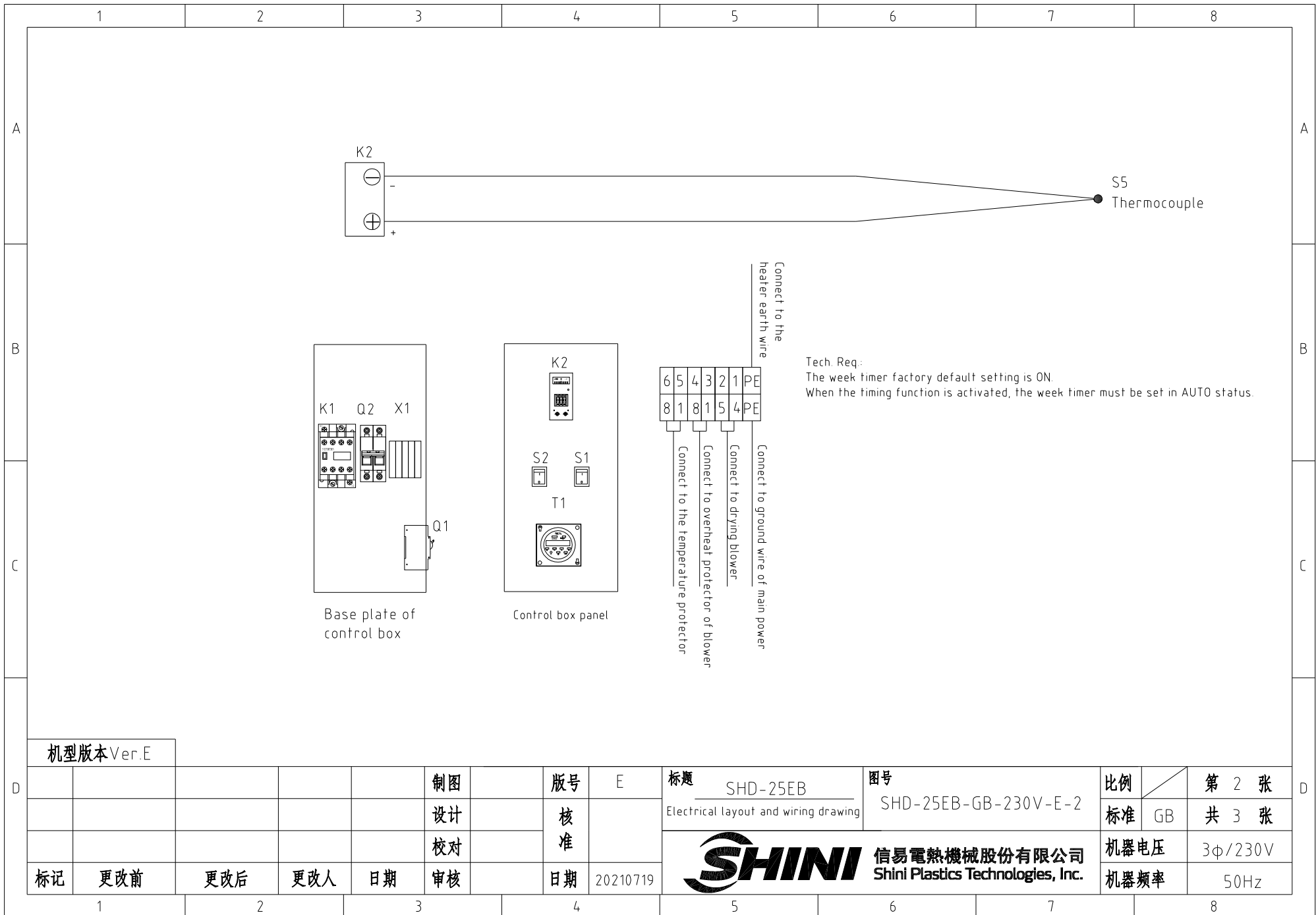

机型版本 Ver.E

				制图		版号		E		标题		图号		比例		第 2 张	
				设计		核准				SHD-25EB		SHD-25EB-GB-230V-E-2		标准		共 3 张	
				校对						Electrical layout and wiring drawing				机器电压		3φ/230V	
标记		更改前		更改后		更改人		日期		20210719		SHINI 信易電熱機械股份有限公司 Shini Plastics Technologies, Inc.		机器频率		50Hz	

1		2		3		4		5		6		7		8	
NO.	Symbol	Name		Manufacturer		Type		Specification		Number	Material number		Remark		
A	1	Q1	Circuit-breaker		TECO		BM-63C/3016S		16A 3P		1	YE40301603000			
	2		Excitation release		YIJIN		MX		110V-400V 50/60Hz		1	YE40023560000			
	3	Q2	Circuit-breaker		TECO		BM-63C/2003S		3A 2P		1	YE40200203000			
	4	K1	Contact		SIEMENS		3RT6016-1AN21		220V 50/60Hz		1	YE00601621000		Delete	
	5	K1	Contact		SIEMENS		3RT6017-1AN21		220V 50/60Hz		1	YE00601721000		New	
	6	K2	Temp. Controller		RONGDA		0-199℃		110V/220V 50/60Hz		1	YE85019900300			
	7	T1	周定时器/week Timer		SHINI		TM69-2		220V 50/60Hz		1	YE86061900100		Delete	
B	8	T1	Week Timer		TBCTL		CN101		200V/250V 50/60Hz		1	YE86101000100		New	
	9		周定时器外壳/week Timer housing		TBCTL		----		----		1	YR40101000100		New	
	10	S1 S2	Alternative switch		ZHONGXUN		T120/55		4P (WH)		2	YE10210400000			
	11	S4	Temperature protector		TONGBAO		KSD301-105		15A		1	----		New(1)	
	12	S5	Thermocouple		SHINI		K TYPE		--		1	----		(1)	
	13	M1	Blower		LONGFENG		0.135kW		230V 50/60Hz		1	----		(1)	
	14	EH1	Heater		SHINI		3.5KW		400V 50/60Hz		1	----		(1)	
C	15	X1	Terminal board		HONEYWELL		SK2.5		2.5mm ²		4-6	YE60002503200		Revised	
	16		Grounding terminal board		HONEYWELL		GK2.5		2.5mm ² PE		1	YE60002503400			
	17		Terminal fittings E/GK series		HONEYWELL		E		GK series		2	YE60000003900			
D	机型版本 Ver.E		Notes: (1)Means it's not the material inside the control box												
					制图		版号	E	标题	SHD-25EB	图号		比例		第 3 张
					设计		核		Electrical Components List	SHD-25EB-GB-230V-E-3		标准	GB	共 3 张	
					校对		准		 信易電熱機械股份有限公司 Shini Plastics Technologies, Inc.			机器电压	3φ/230V		
标记	更改前	更改后	更改人	日期	审核	日期	20210719				机器频率	50Hz			
1		2		3		4		5		6		7		8	

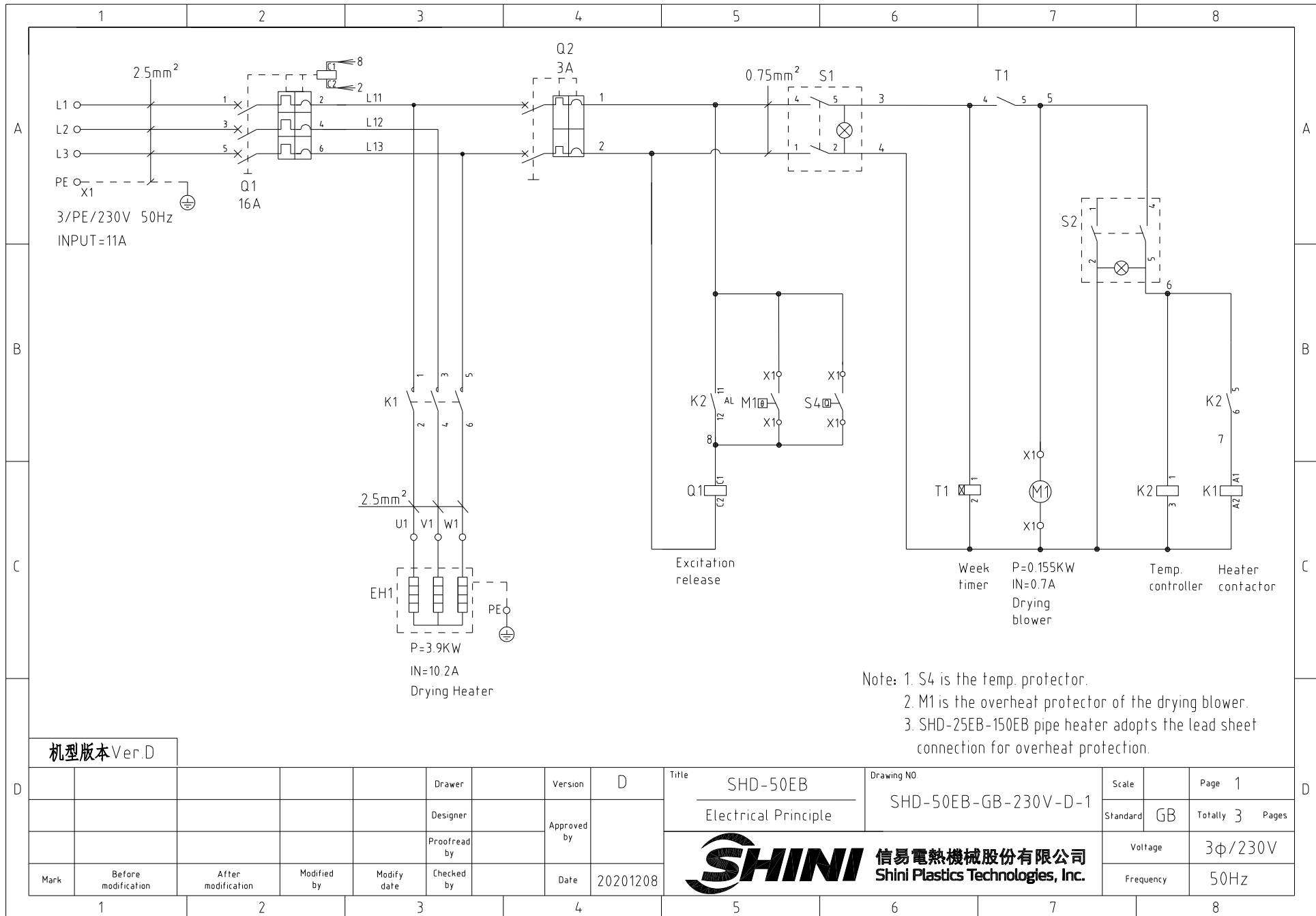

机型版本 Ver.D

				Drawer	Version	D	Title	SHD-50EB	Drawing NO	Scale	Page	1
				Designer	Approved by		Electrical Principle	SHD-50EB-GB-230V-D-1		Standard	Totally	3 Pages
				Proofread by	Date	20201208	 信易電熱機械股份有限公司 Shini Plastics Technologies, Inc.		Voltage		3φ/230V	
Mark	Before modification	After modification	Modified by	Modify date	Checked by				Frequency		50Hz	

1

2

3

4

5

6

7

8

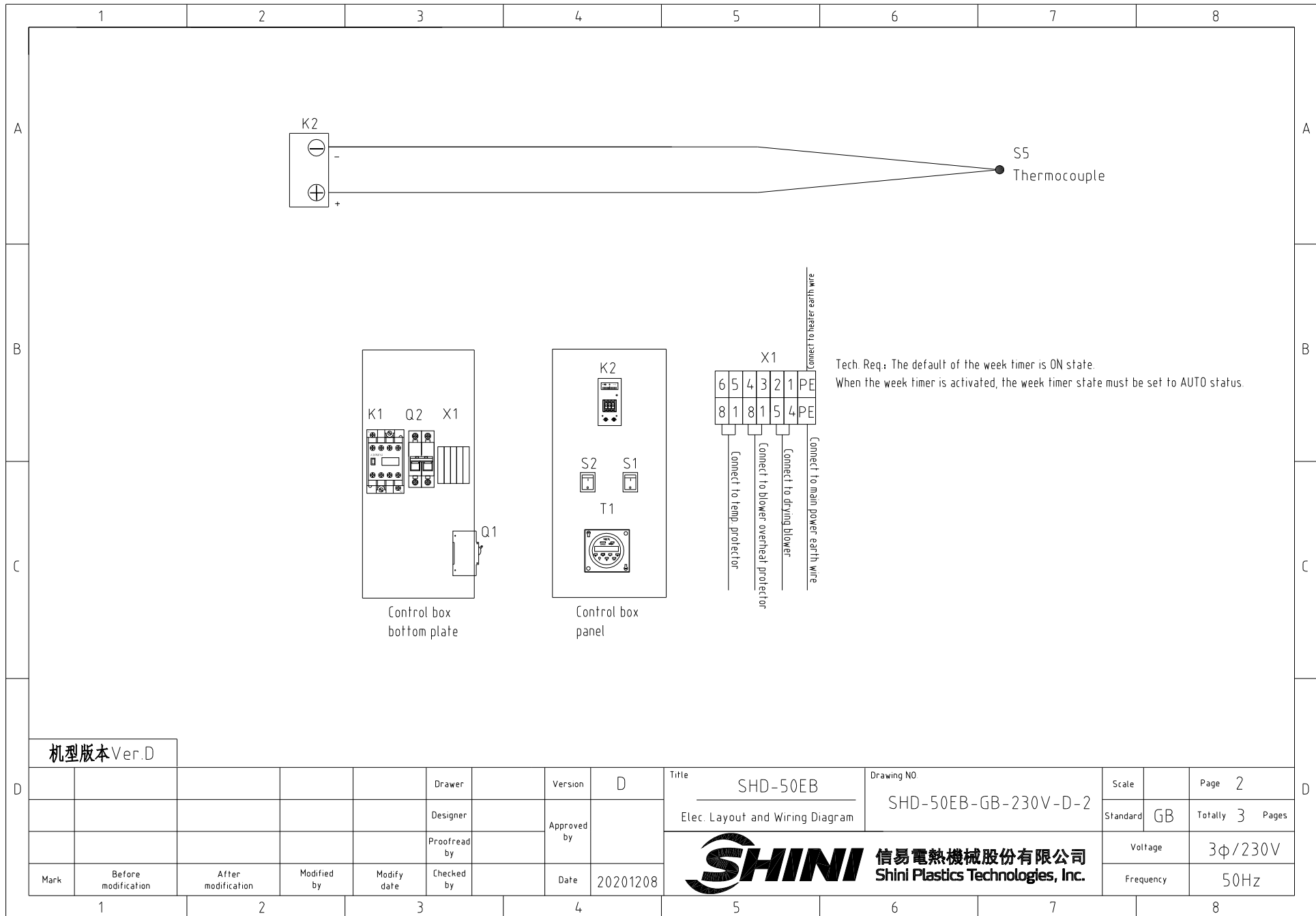

机型版本 Ver.D

				Drawer	Version	D	Title	SHD-50EB	Drawing NO	SHD-50EB-GB-230V-D-2	Scale	Page	2	
				Designer	Approved by		Elec. Layout and Wiring Diagram				Standard	GB	Totally	3
				Proofread by	Date	20201208	 信易電熱機械股份有限公司 Shini Plastics Technologies, Inc.				Voltage	3φ/230V		
Mark	Before modification	After modification	Modified by	Modify date	Checked by						Frequency	50Hz		

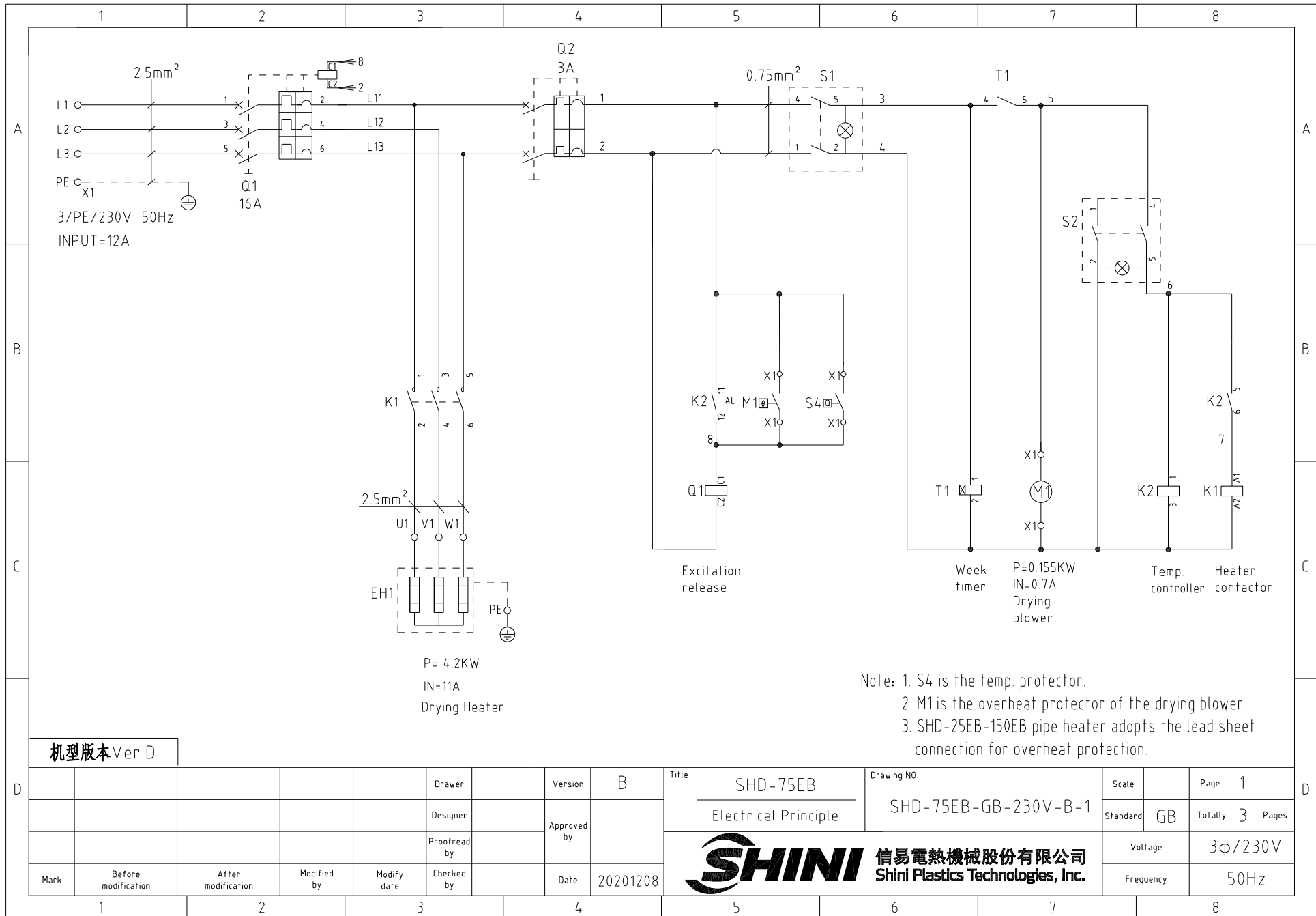

机型版本 Ver.D

				Drawer	Version	B	Title	SHD-75EB	Drawing NO	SHD-75EB-GB-230V-B-1	Scale	Page	1	
				Designer	Approved by		Electrical Principle				Standard	GB	Totally	3 Pages
				Proofread by	Date	20201208	 信易電熱機械股份有限公司 Shini Plastics Technologies, Inc.				Voltage	3φ/230V		
Mark	Before modification	After modification	Modified by	Modify date	Checked by						Frequency	50Hz		

1

2

3

4

5

6

7

8

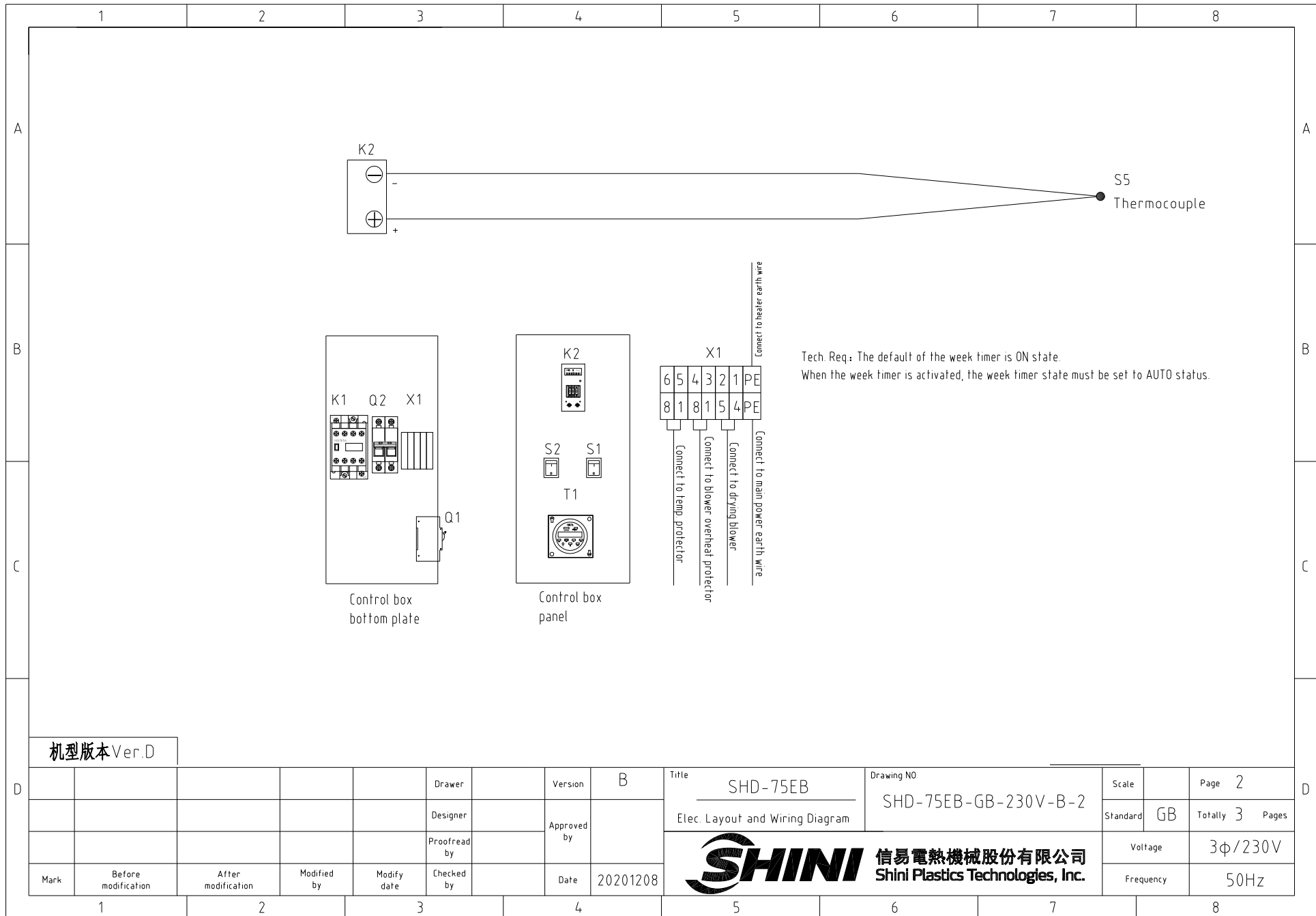

机型版本 Ver.D

				Drawer	Version	B	Title	SHD-75EB	Drawing NO	SHD-75EB-GB-230V-B-2	Scale	Page	2
				Designer	Approved by		Elec. Layout and Wiring Diagram				Standard	GB	Totally 3 Pages
				Proofread by	Date	20201208	 信易電熱機械股份有限公司 Shini Plastics Technologies, Inc.				Voltage	3φ/230V	
Mark	Before modification	After modification	Modified by	Modify date	Checked by						Frequency	50Hz	

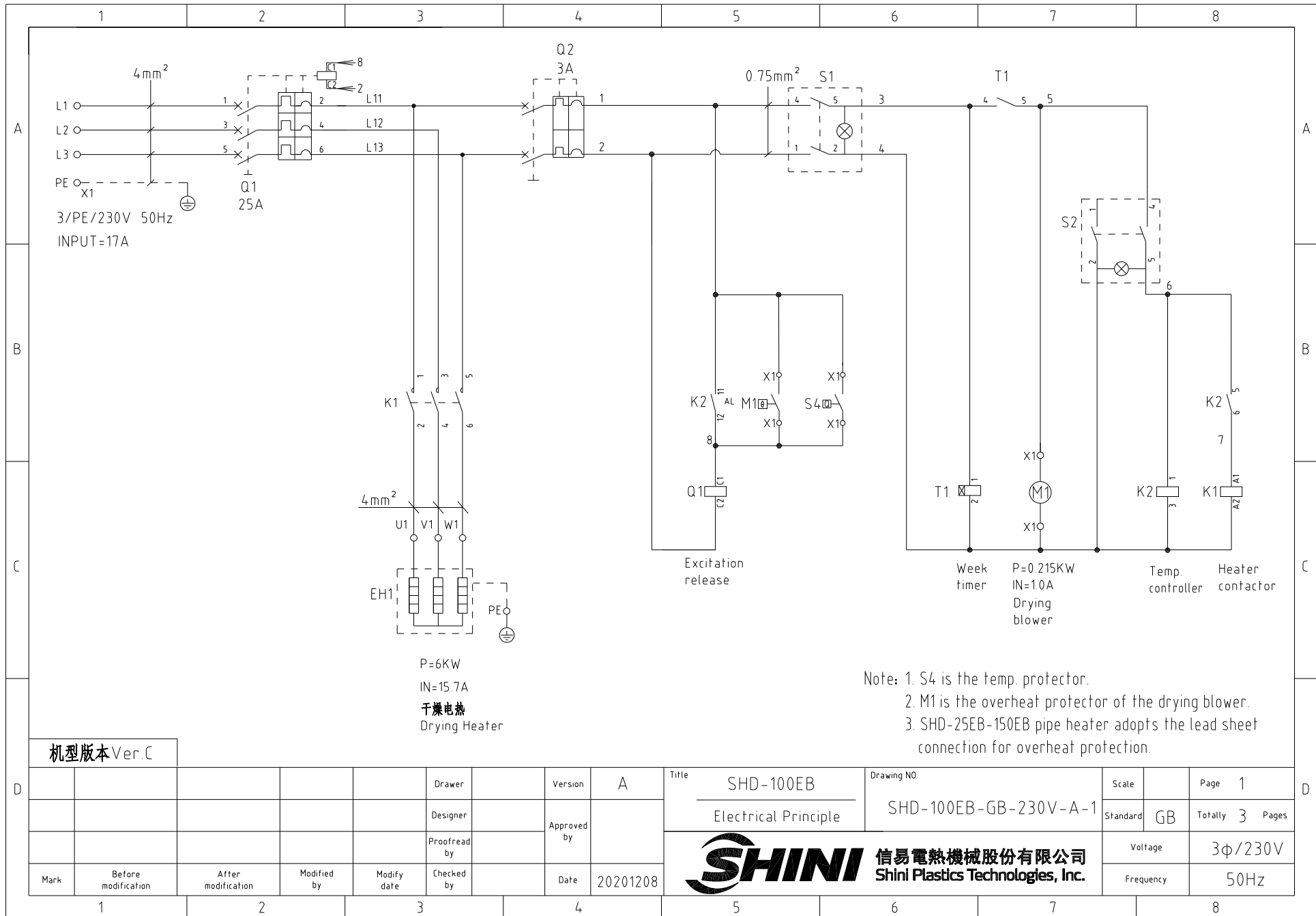

机型版本 Ver.C

				Drawer	Version	A	Title	SHD-100EB	Drawing NO	Scale	Page	1
				Designer	Approved by		Electrical Principle	SHD-100EB-GB-230V-A-1	Standard	GB	Totally	3 Pages
				Proofread by	Date	20201208	 信易电热机械股份有限公司 Shini Plastics Technologies, Inc.		Voltage	3φ/230V		
Mark	Before modification	After modification	Modified by	Modify date	Checked by				Frequency	50Hz		

1 2 3 4 5 6 7 8

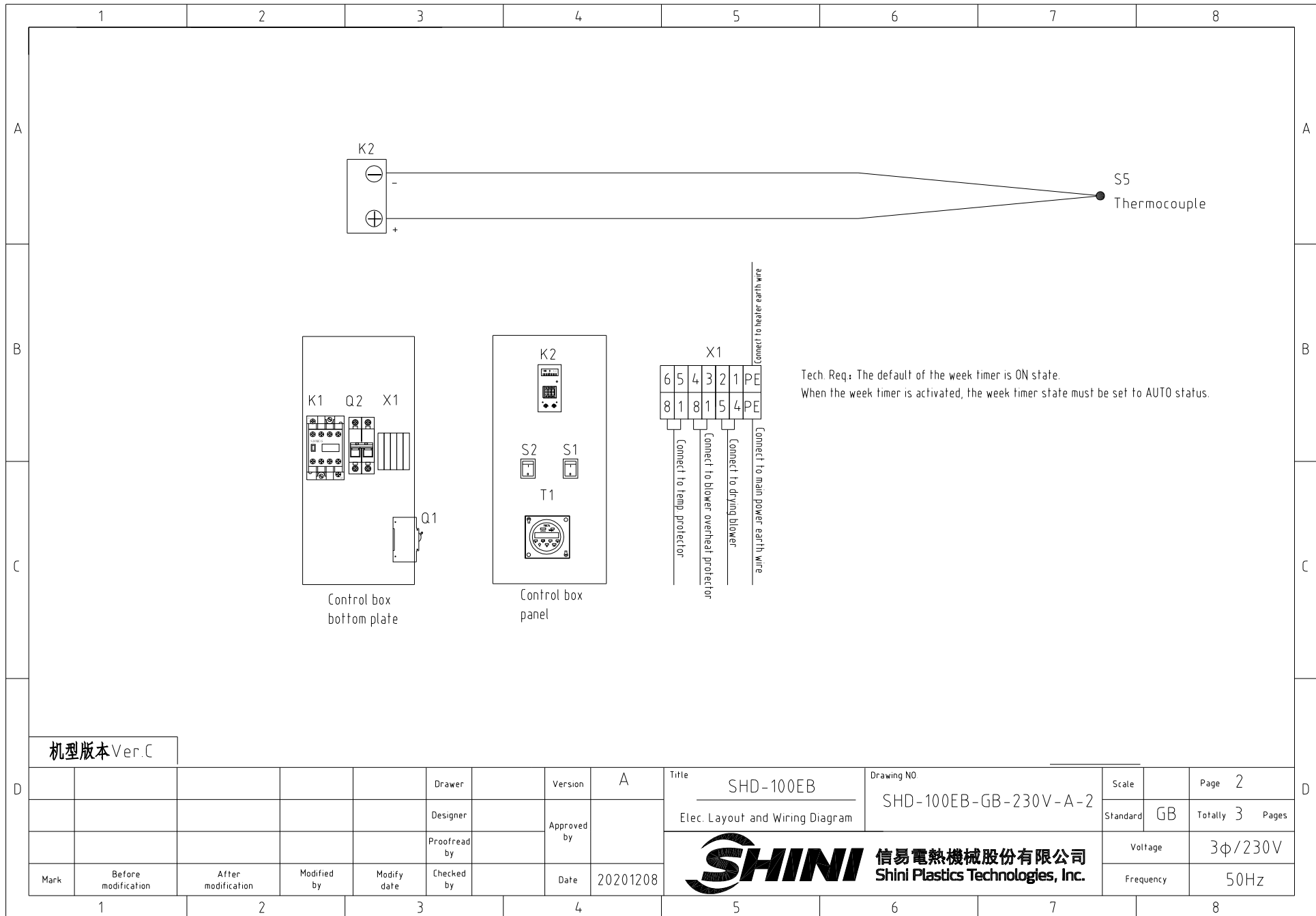

机型版本 Ver.C

Mark	Before modification	After modification	Modified by	Modify date	Checked by	Date	20201208
					Drawer	Version	A
					Designer	Approved by	
					Proofread by		

Title		SHD-100EB		Drawing NO		SHD-100EB-GB-230V-A-2		Scale	Page
Elec. Layout and Wiring Diagram								Standard	Totally
								Voltage	3φ/230V
								Frequency	50Hz



Page	2
Totally	3 Pages
Voltage	3φ/230V
Frequency	50Hz

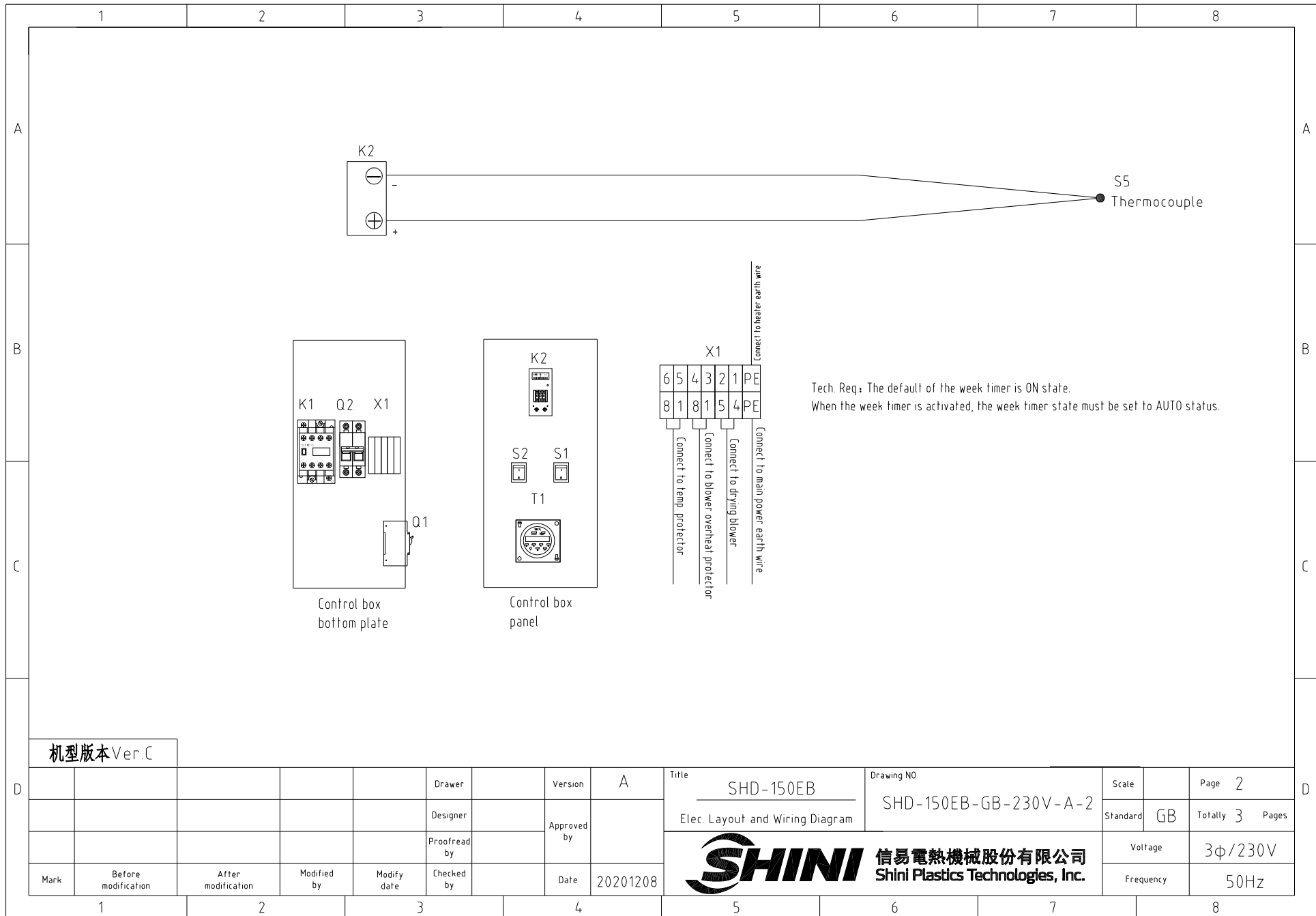

机型版本 Ver.C

					Drawer	Version	A	Title	SHD-150EB	Drawing NO	SHD-150EB-GB-230V-A-2	Scale	Page	2
					Designer	Approved by		Elec. Layout and Wiring Diagram			Standard	GB	Totally	3 Pages
					Proofread by	Date	20201208	 信易電熱機械股份有限公司 Shini Plastics Technologies, Inc.		Voltage		3φ/230V		
Mark	Before modification	After modification	Modified by	Modify date	Checked by		Frequency			50Hz				

1		2		3		4		5		6		7		8	
NO.	Symbol	Name		Manufacturer		Type		Specification		Number	Material number		Remark		
1	Q1	Circuit breaker		TECO		BM-63C/3025S		25A 3P		1	YE40302503000				
2		Excitation release		YIJIN		MX		230V 50/60Hz		1	YE40023560000				
3	Q2	Circuit breaker		TECO		BM-63C/2003S		3A 2P		1	YE40200203000				
4	K1	Contactor		SIEMENS		3RT6027-1AN20		220V 50/60Hz		1	YE00602722000				
5	K2	Temp. controller		RONGDA		0-199℃		110V/220V 50/60Hz		1	YE85019900300				
6	T1	周定时器/weekTimer		SHINI		TM69-2		230V 50/60Hz		1	YE86061900100		Cancel		
7	T1	Week timer		TBCTL		CN101		200V/250V 50/60Hz		1	YE86101000100		Newly increased		
8		Week timer housing		TBCTL		----		----		1	YR40101000100		Newly increased		
9	S1 S2	Alternative switch		ZHONGXUN		T120/55		4P (WH)		2	YE10210400000				
10	S4	Temperature protector		TONGBAO		KSD301-105		15A		1	----		New (1)		
11	S5	Thermocouple		SHINI		K TYPE		--		1	----		(1)		
12	M1	Blower		LONGFENG		0.215KW		230V 50/60Hz		1	----		(1)		
13	EH1	Heater		SHINI		6KW		380V 50/60Hz		1	----		(1)		
14	X1	Terminal board		Honeywell		SK2.5		2.5mm ²		4-6	YE60002503200		Modified		
15		Wiring terminal board		HONEYWELL		GK5PE		4mm ² PE		1	YE60000403500				
16		Terminal fittings E/GK series(honeywell)		HONEYWELL		E		GK series		2	YE60000003900				
机型版本 Ver.C		Notes: (1)Materials not in the control box.													
				Drawer		Version		A		Title		SHD-150EB		Drawing NO	
				Designer		Approved by				Elec. Parts List 1		SHD-150EB-GB-230V-A-3		Scale	
				Proofread by		Date		20201208				Standard		GB	
Mark		Before modification		After modification		Modified by		Modify date		Checked by		Voltage		3φ/230V	
1		2		3		4		5		6		7		8	
												Frequency		50Hz	



信易電熱機械股份有限公司
Shini Plastics Technologies, Inc.

Page 3
Totally 3 Pages
Voltage 3φ/230V
Frequency 50Hz

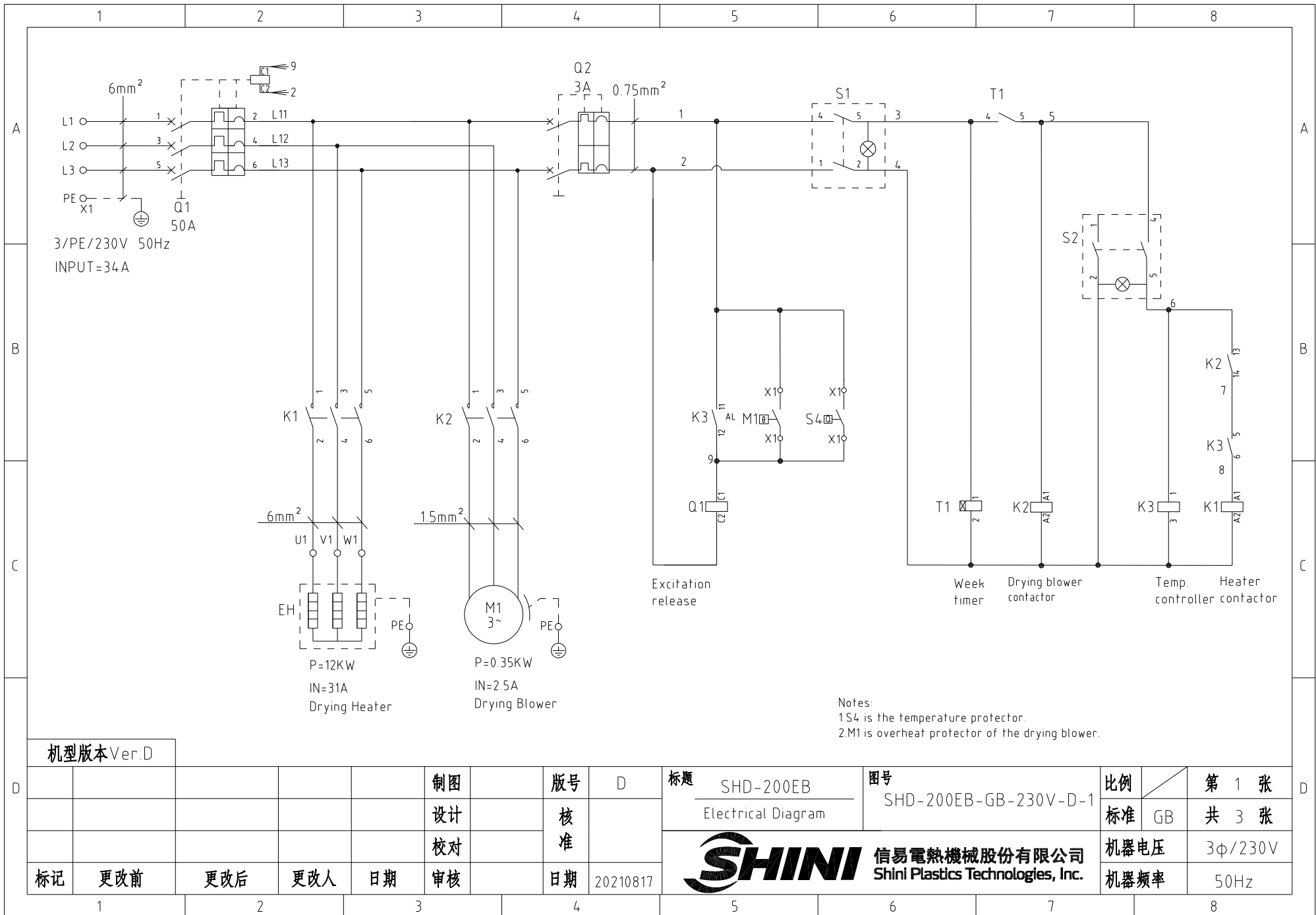

机型版本 Ver.D

				制图	版号	D	标题	SHD-200EB	图号	SHD-200EB-GB-230V-D-1	比例	第 1 张
				设计	核准		Electrical Diagram		标准	GB	共 3 张	
				校对	核准		 信易電熱機械股份有限公司 Shini Plastics Technologies, Inc.		机器电压	3φ/230V		
标记	更改前	更改后	更改人	日期	审核	日期			20210817	机器频率	50Hz	

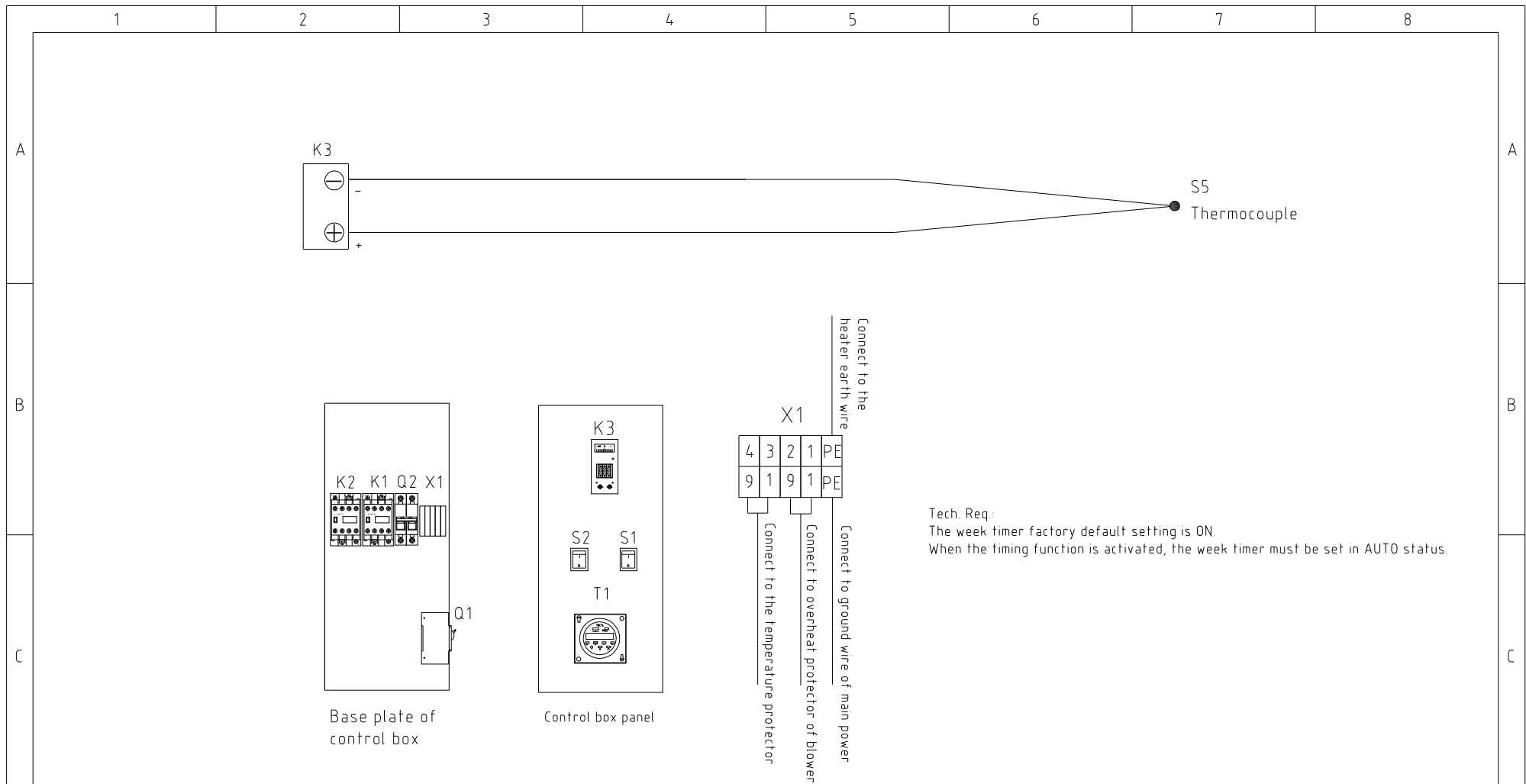

Tech. Req:
 The week timer factory default setting is ON.
 When the timing function is activated, the week timer must be set in AUTO status.

机型版本 Ver.D

					制图	版号	D	标题	SHD-200EB	图号	SHD-200EB-GB-230V-D-2	比例	第 2 张
					设计	核准		Electrical layout and wiring drawing		标准	GB	共 3 张	
					校对	核准		 信易電熱機械股份有限公司 Shini Plastics Technologies, Inc.		机器电压	3φ/230V		
标记	更改前	更改后	更改人	日期	审核	日期	20210817			机器频率	50Hz		

1		2		3		4		5		6		7		8	
NO.	Symbol	Name		Manufacturer		Type		Specification		Number	Material number		Remark		
A	1	Q1	Circuit-breaker		TECO		BM-63C/3050S		50A 3P		1	YE40305003000			
	2		Excitation release		YIJIN		MX		230V 50/60Hz		1	YE40023560000			
	3	Q2	Circuit-breaker		TECO		BM-63C/1003S		3A 2P		1	YE40200203000			
	4	K1	Contactor		SIEMENS		3RT6028-1AN20		220V 50/60Hz		1	YE00602822000			
	5	K2	Contactor		SIEMENS		3RT6015-1AN21		220V 50/60Hz		1	YE00601521000			
	6	K3	Temp. Controller		SHINI		0-199°C		110V/220V 50/60Hz		1	YE85019900300			
	7	T1	Week Timer		TBCTL		CN101		200V/250V 50/60Hz		1	YE86101000100			
	8		Timer housing		TBCTL		----		----		1	YR40101000100			
	9	S1 S2	Alternative switch		ZHONGXUN		R210-C5LBW		4P (WH)		2	YE10210400000			
	10	S4	Temperature protector		TONGBAO		KSD301-105		15A		1	----		(1)	
B	11	S5	Thermocouple		SHINI		K TYPE		----		1	----		(1)	
	12	X1	Terminal board		HONEYWELL		SK2.5		2.5mm ²		4	YE60002503200			
	13		Grounding terminal board		HOEYWELL		GK6PE		6mm ² PE		1	YE60000603500			
	14		Terminal fittings E/GK series		HONEYWELL		E		GK series		2	YE60000003900			
	15	M1	Blower		LONGFENG		0.32KW		230V 50/60Hz		1	----		(1)	
	16	EH1	Heater		SHINI		12KW		230V 50/60Hz		1	----		(1)	

机型版本 Ver.D		Notes: (1)Means it's not the material inside the control box.													
					制图		版本号	D	标题	SHD-200EB	图号	SHD-200EB-GB-230V-D-3	比例	第 3 张	D
					设计		核		Electrical Components List				标准	共 3 张	
					校对		准		 信易電熱機械股份有限公司 Shini Plastics Technologies, Inc.			机器电压		3φ/230V	
标记	更改前	更改后	更改人	日期	审核	日期	20210817	机器频率				50Hz			
1		2		3		4		5		6		7		8	

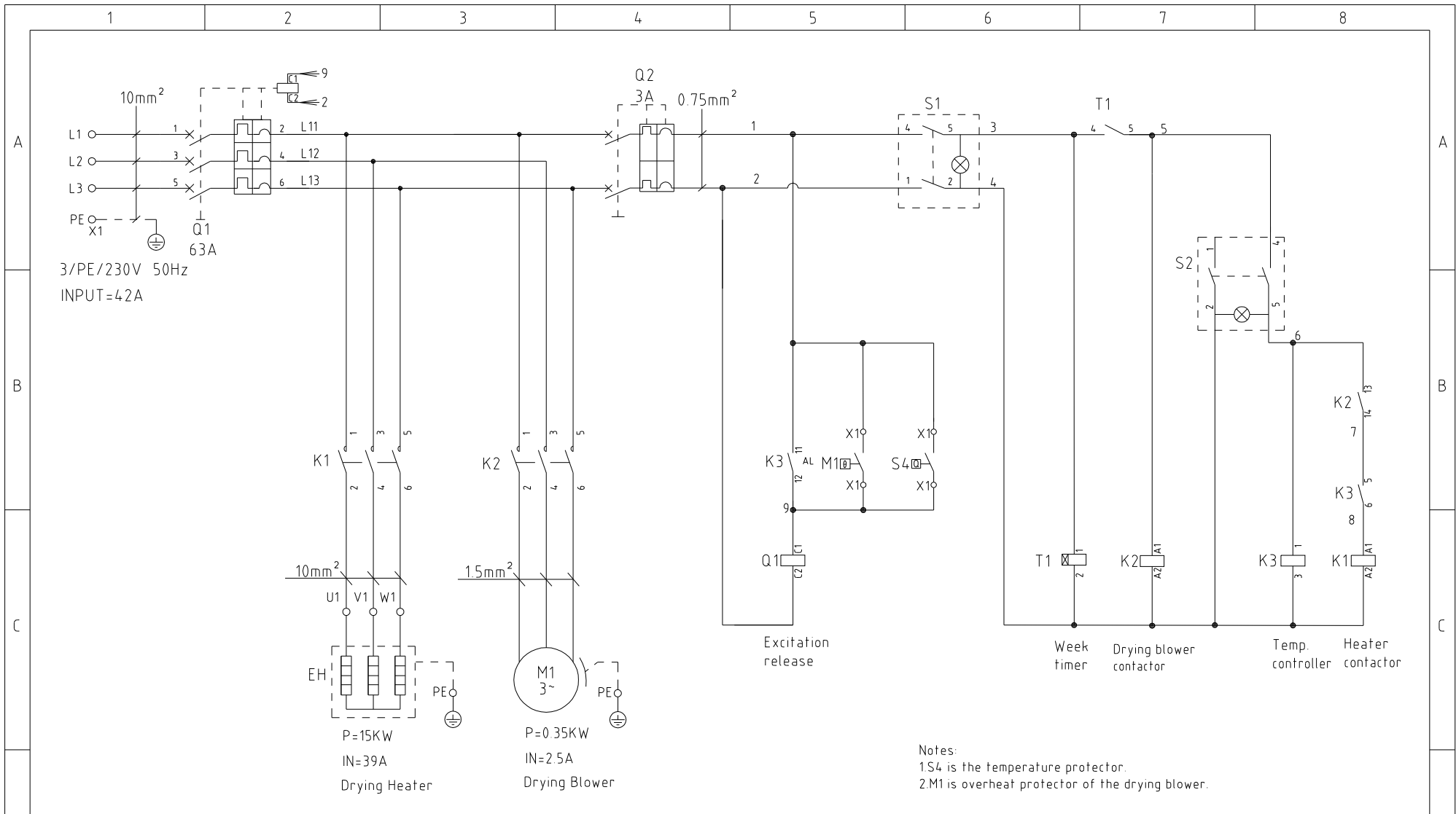

机型版本 Ver.D						制图	版号	D	标题	SHD-300EB	图号	比例	第 1 张
						设计	核准		Electrical Diagram	SHD-300EB-GB-230V-D-1	标准	GB	共 3 张
						校对	核准		 信易電熱機械股份有限公司 Shini Plastics Technologies, Inc.		机器电压	3φ/230V	
标记	更改前	更改后	更改人	日期	审核	日期	20210817	机器频率			50Hz		

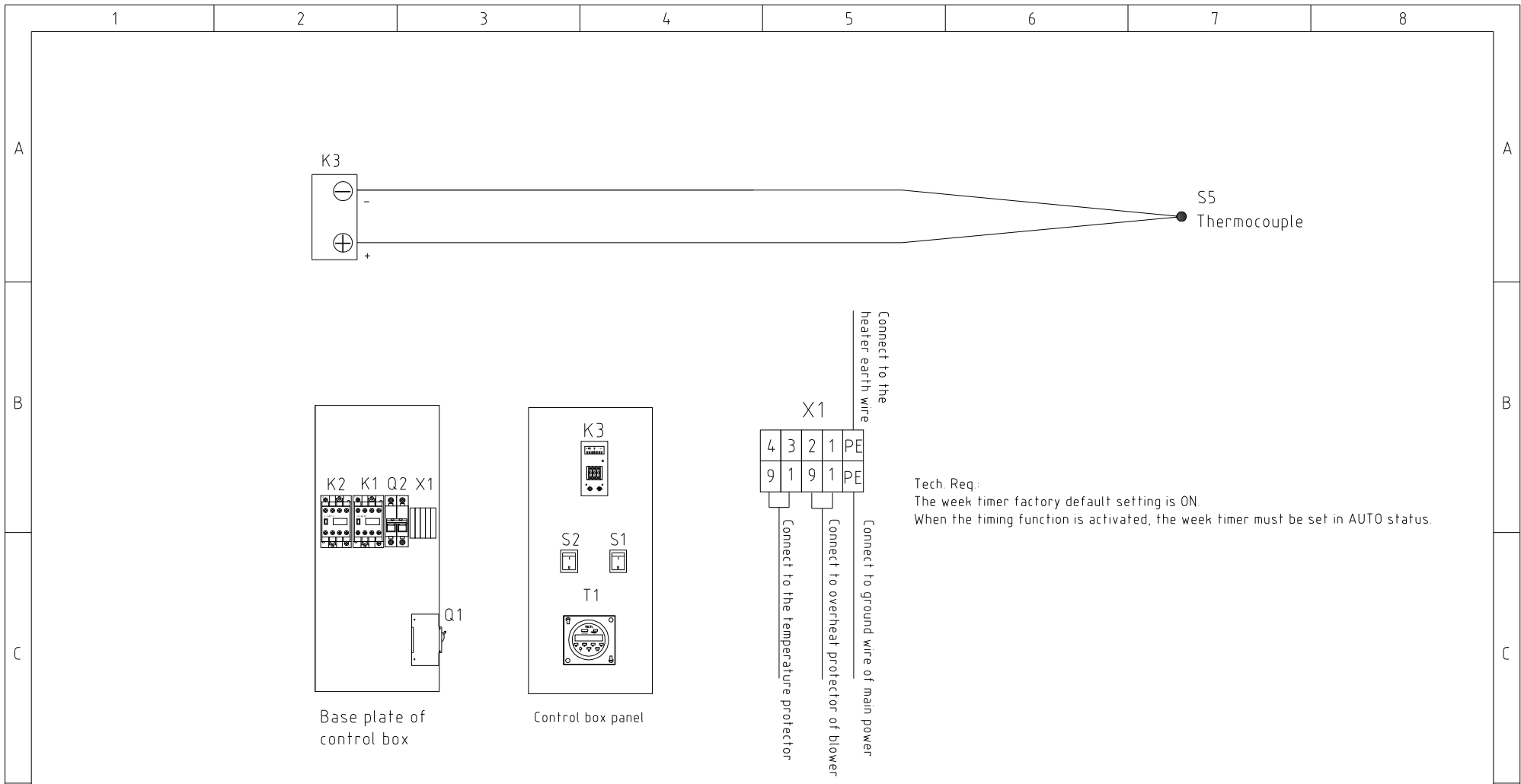

机型版本 Ver.D

				制图		版号		D		标题		图号		比例		第 2 张	
				设计		核				SHD-300EB		SHD-300EB-GB-230V-D-2		标准		共 3 张	
				校对		准				Electrical layout and wiring drawing				GB			
标记		更改前		更改后		更改人		日期		20210817		SHINI 信易電熱機械股份有限公司 Shini Plastics Technologies, Inc.		机器电压		3φ/230V	
														机器频率		50Hz	

1		2		3		4		5		6		7		8	
NO.	Symbol	Name		Manufacturer		Type		Specification		Number	Material number		Remark		
1	Q1	Circuit-breaker		TECO		BM-63C/3063S		63A 3P		1	YE40306303000				
2		Excitation release		YIJIN		MX		110V-400V 50/60Hz		1	YE40023560000				
3	Q2	Circuit-breaker		TECO		BM-63C/2003S		3A 2P		1	YE40200203000				
4	K1	Contactor		SIEMENS		3RT5036-1AN20		220V 50/60Hz		1	YE00503600000				
5	K2	Contactor		SIEMENS		3RT6015-1AN21		220V 50/60Hz		1	YE00601521000				
6	K3	Temp. Controller		RONGDA		0-199℃		110V/220V 50/60Hz		1	YE85019900300				
7	T1	Week Timer		TBCTL		CN101		200V/250V 50/60Hz		1	YE86101000100				
8		Timer housing		TBCTL		----		----		1	YR40101000100				
9	S1 S2	Alternative switch		ZHONGXUN		T120/55		4P (WH)		2	YE10210400000				
10	S4	Temperature protector		TONGBAO		KSD301-105		15A		1	----				
11	S5	Thermocouple		SHINI		K TYPE		----		1	----		(1)		
12	M1	Blower		LONGFENG		0.32kW		230V 50/60Hz		1	----		(1)		
13	EH1	Heater		SHINI		15KW		230V 50/60Hz		1	----		(1)		
14	X1	Terminal board		Honeywell		SK25		2.5mm ²		4	YE60002503200		(1)		
15		Grounding terminal board		Honeywell		GK10PE		10mm ² PE		1	YE600001003500				
16		Terminal fittings E/GK series		Honeywell		E		GK series		2	YE60000003900				

机型版本 Ver.D		Notes: (1)Means it's not the material inside the control box.														
					制图		版本号	D	标题	SHD-300EB		图号		比例	第 3 张	
					设计		核		Electrical Components List		SHD-300EB-GB-230V-D-3		标准	GB	共 3 张	
					校对		准		 信易電熱機械股份有限公司 Shini Plastics Technologies, Inc.		机器电压		3φ/230V			
标记	更改前	更改后	更改人	日期	审核	日期	20210817	机器频率			50Hz					
1		2		3		4		5		6		7		8		

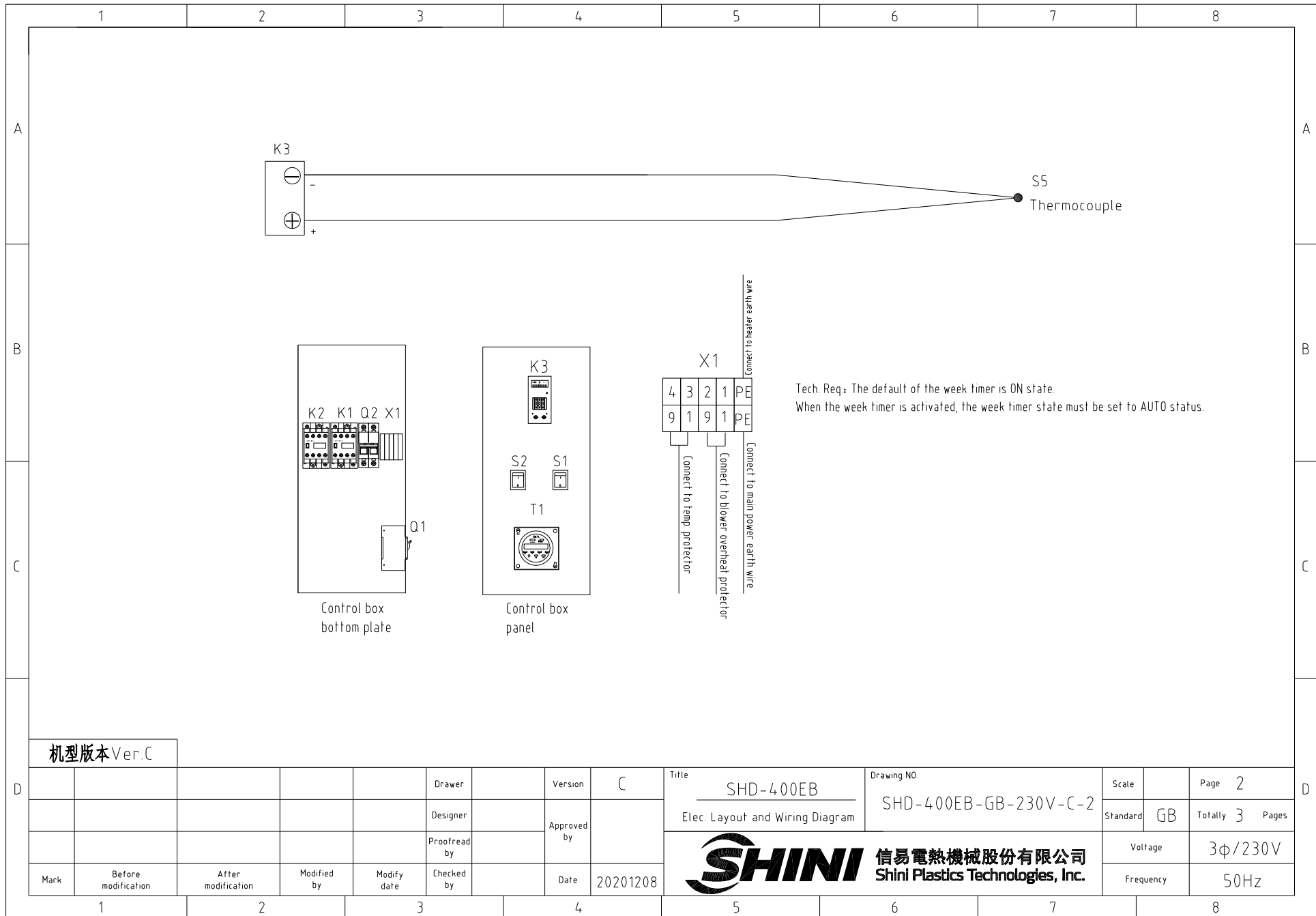

机型版本 Ver.C

					Drawer	Version	C	Title	SHD-400EB	Drawing NO	SHD-400EB-GB-230V-C-2	Scale	Page	2	
					Designer	Approved by		Elec. Layout and Wiring Diagram				Standard	GB	Totally	3 Pages
					Proofread by	Date	20201208	 信易電熱機械股份有限公司 Shini Plastics Technologies, Inc.				Voltage	3φ/230V		
Mark	Before modification	After modification	Modified by	Modify date	Checked by							Frequency	50Hz		

1		2		3		4		5		6		7		8	
NO.	Symbol	Name		Manufacturer		Type		Specification		Number	Material number		Remark		
1	Q1	Circuit breaker		TECO		BM-100D/3080S		80A 3P		1	YE40308003000				
2		Excitation release		YIJIN		MX		110V-400V 50/60Hz		1	YE40023560000				
3	Q2	Circuit breaker		TECO		BM-63C/2003S		3A 2P		1	YE40200203000				
4	K1	Contactor		SIEMENS		3RT5044-1AN20		220V 50/60Hz		1	YE00504400000				
5	K2	Contactor		SIEMENS		3RT6015-1AN21		220V 50/60Hz		1	YE00601521000				
6	K3	Temp. controller		RONGDA		0-199°C		110V/220V 50/60Hz		1	YE85019900300				
7	T1	周定时器/week Timer		SHINI		TM619-2		230V 50/60Hz		1	YE86061900100		Cancel		
8	T1	Week timer		TBCTL		CN101		200V/250V 50/60Hz		1	YE86101000100		Newly increased		
9		Week timer housing		TBCTL		----		----		1	YR40101000100		Newly increased		
10	S1 S2	Alternative switch		ZHONGXUN		T120/55		4P (WH)		2	YE10210400000				
11	S4	Temperature protector		TONGBAO		KSD301-105		15A		1	----		New (1)		
12	S5	Thermocouple		SHINI		K TYPE		----		1	----		(1)		
13	M1	Blower		LONGFENG		0.34kW		230V 50/60Hz		1	----		(1)		
14	EH1	Heater		SHINI		18KW		230V 50/60Hz		1	----		(1)		
15	X1	Terminal board		Honeywell		SK25		2.5mm ²		4	YE60002503200				
16		Wiring terminal board		Honeywell		GK6PE		6mm ² PE		1	YE60000603500				
17		Terminal fittings E/GK series(honeywell)		Honeywell		E		GK series		2	YE60000003900				
机型版本 Ver.C		Notes: (1)Materials not in the control box.													
				Drawer		Version		C		Title		SHD-400EB		Drawing NO	
				Designer		Approved by				Elec. Parts List 1		SHD-400EB-GB-230V-C-3		Scale	
				Proofread by		Date		20201208				Standard		GB	
				Checked by								Voltage		3Φ/230V	
Mark		Before modification		After modification		Modified by		Modify date				Frequency		50Hz	
1		2		3		4		5		6		7		8	



信易電熱機械股份有限公司
Shini Plastics Technologies, Inc.

Page	3
Totally	3 Pages
Voltage	3Φ/230V
Frequency	50Hz

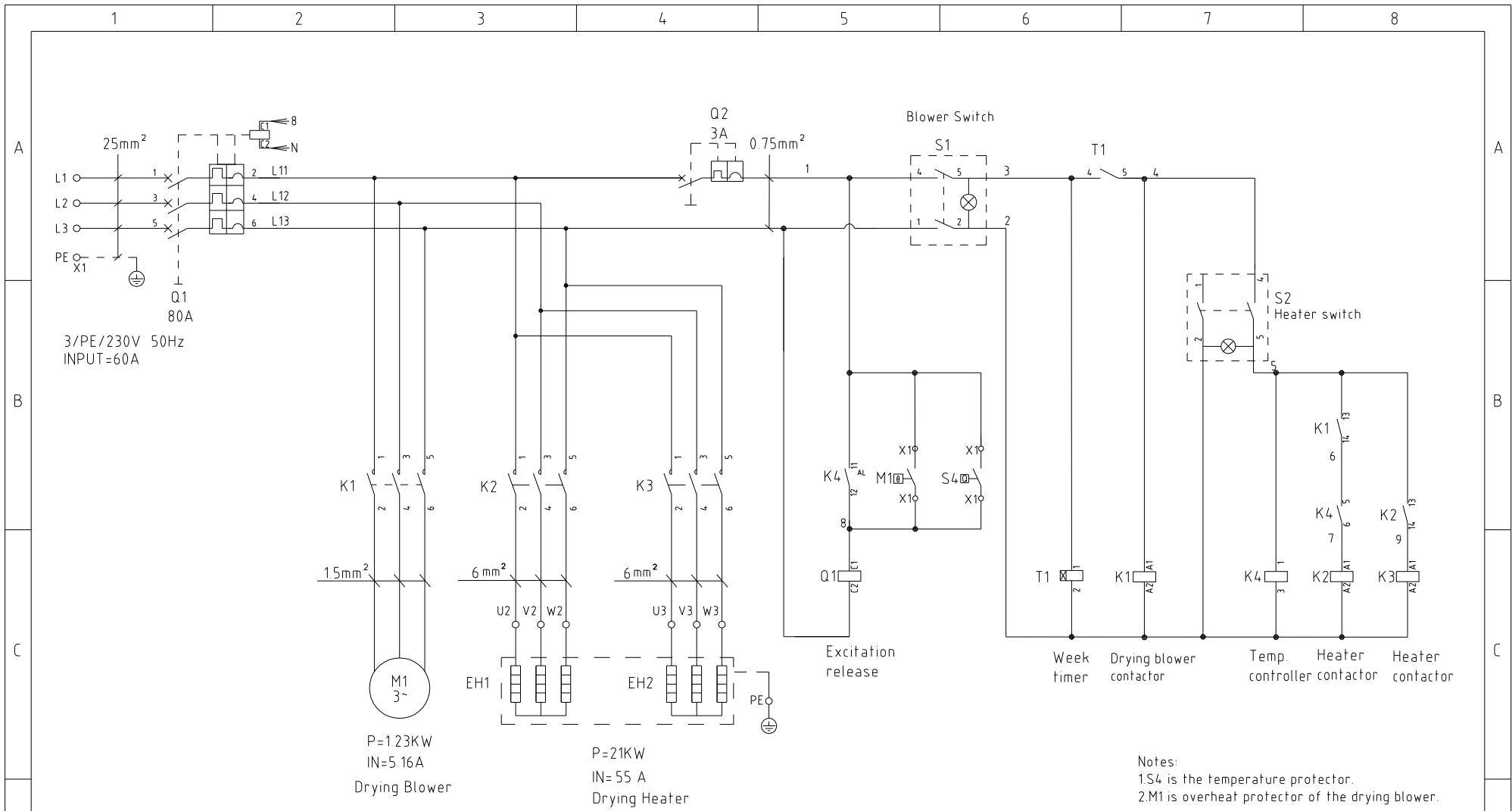

机型版本 Ver.A

				制图		版号 0		标题 SHD-600EB		图号 SHD-600EB-GB-230V-0-1		比例		第 1 张	
				设计		核准		Electrical Diagram		标准 GB		共 3 张			
				校对						机器电压		3φ/230V			
标记		更改前		更改后		更改人		日期 20210813		机器频率		50Hz			



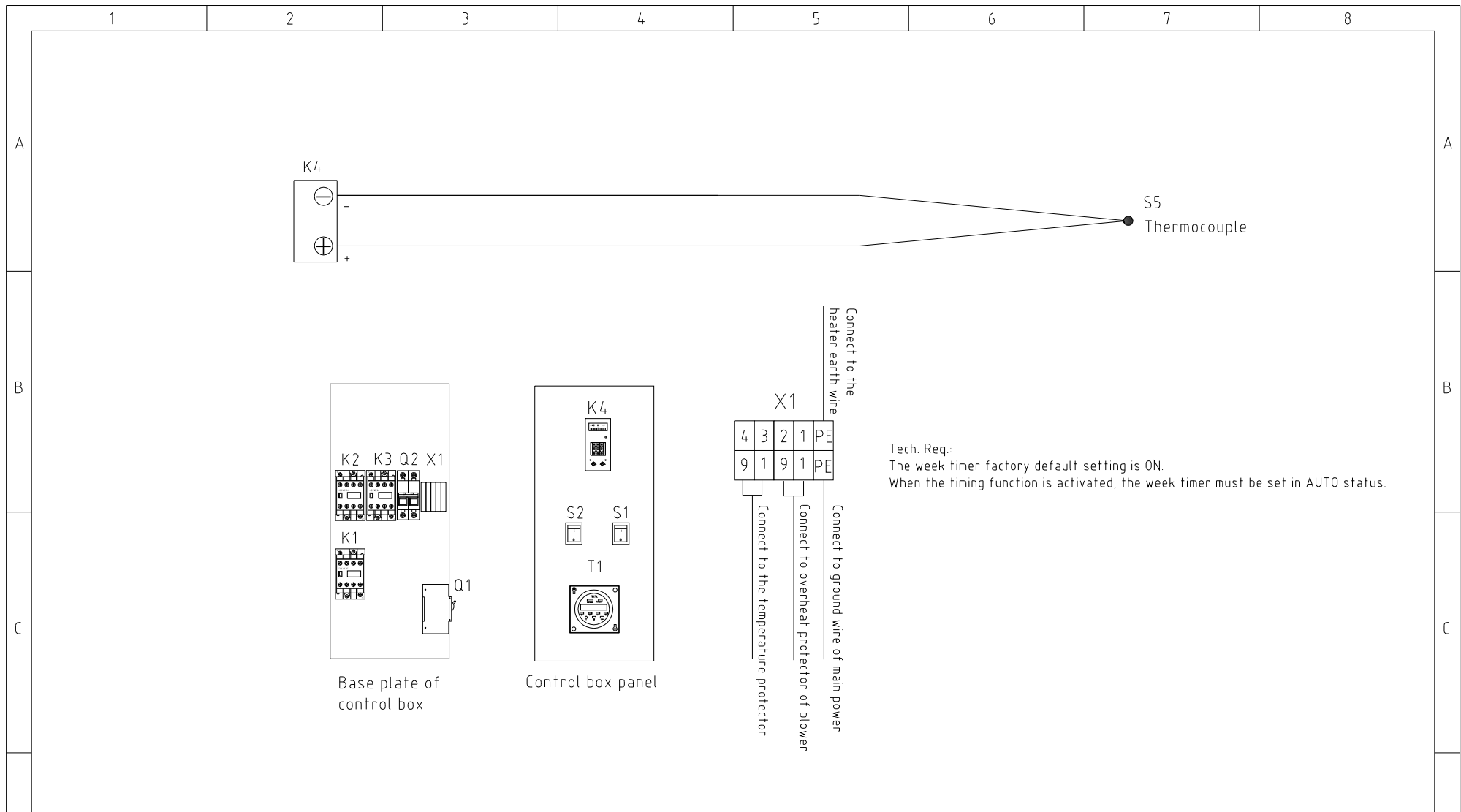

机型版本 Ver.A

				制图		版号		0		标题		SHD-600EB		图号		SHD-600EB-GB-230V-0-2		比例		第 2 张	
				设计		核准				Electrical layout and wiring drawing				标准		GB		共 3 张			
				校对						 信易電熱機械股份有限公司 Shini Plastics Technologies, Inc.		机器电压		3φ/230V							
标记		更改前		更改后		更改人		日期				20210813		机器频率		50Hz					

